



Contact SAMSUNG WORLDWIDE

If you have any questions or comments relating to Samsung products, please contact the SAMSUNG customer care centre.

Country	Customer Care Centre ☎	Web Site
IRELAND	0818 717 100	www.samsung.com/ie
U.K	0845 SAMSUNG (7267864)	www.samsung.com/uk



LED TV user manual

imagine the possibilities

Thank you for purchasing this Samsung product.
To receive more complete service, please register
your product at

www.samsung.com/register

Model _____ Serial No. _____



Figures and illustrations in this User Manual are provided for reference only and may differ from actual product appearance. Product design and specifications may be changed without notice.

Digital TV notice

1. Functionalities related to Digital TV (DVB) are only available in countries/areas where DVB-T (MPEG2 and MPEG4 AVC) digital terrestrial signals are broadcasted or where you are able to access to a compatible DVB-C (MPEG2 and MPEG4 AAC) cable-TV service. Please check with your local dealer the possibility to receive DVB-T or DVB-C signal.
2. DVB-T is the DVB European consortium standard for the broadcast transmission of digital terrestrial television and DVB-C is that for the broadcast transmission of digital TV over cable. However, some differentiated features like EPG (Electric Programme Guide), VOD (Video On Demand) and so on, are not included in this specification. So, they cannot be workable at this moment.
3. Although this TV set meets the latest DVB-T and DVB-C standards, as of [August, 2008], the compatibility with future DVB-T digital terrestrial and DVB-C digital cable broadcasts cannot be guaranteed.
4. Depending on the countries/areas where this TV set is used some cable-TV providers may charge an additional fee for such a service and you may be required to agree to terms and conditions of their business.
5. Some Digital TV functions might be unavailable in some countries or regions and DVB-C might not work correctly with some cable service providers.
6. For more information, please contact your local Samsung customer care centre.
 - ✎ The reception quality of TV may be affected due to differences in broadcasting method between the countries. Please check the TV performance in the local SAMSUNG Authorized Dealer, or the Samsung Call Centre whether it can be improved by reconfiguring TV setting or not.

Still image warning

Avoid displaying still images (like jpeg picture files) or still image element (like TV programme logo, panorama or 4:3 image format, stock or news bar at screen bottom etc.) on the screen. Constant displaying of still picture can cause ghosting of LED screen, which will affect image quality. To reduce risk of this effect, please follow below recommendations:

- Avoid displaying the same TV channel for long periods.
- Always try do display any image on full screen, use TV set picture format menu for best possible match.
- Reduce brightness and contrast values to minimum required to achieve desired picture quality, exceeded values may speed up the burnout process.
- Frequently use all TV features designed to reduce image retention and screen burnout, refer to proper user manual section for details.

✎ **WARNINGS:** Image retention, commonly known as screen burn-in, can occur on most types of television if the same image is displayed continuously. The most common causes of image retention are logos that remain stationary on the TV screen. These logos are common on many programmes received via a Set-top Box. To reduce this risk, avoid displaying still images for long durations and lower the brightness or contrast settings to decrease the intensity of the picture. Extended viewing of movies and programs in aspect ratios that are different from the aspect ratio of the TV may cause image retention. Always endeavour to avoid black borders top or bottom by using the zoom function. This will help eliminate the black borders and fit the picture to the entire area of the screen. Using a video game console may cause image retention and is not recommended. When using a PC input, avoid displaying still images for long durations and reduce the brightness or contrast settings to decrease the intensity of the picture.

✎ **IMPORTANT:** Image retention issues are not covered by your Samsung® warranty.

Securing the Installation Space

Keep the required distances between the product and other objects (e.g. walls) to ensure proper ventilation. Failing to do so may result in fire or a problem with the product due to an increase in the internal temperature of the product.

- ✎ When using a stand or wall-mount, use parts provided by Samsung Electronics only.
- If you use parts provided by another manufacturer, it may result in a problem with the product or an injury due to the product falling.

✎ The appearance may differ depending on the product.

Installation with a stand

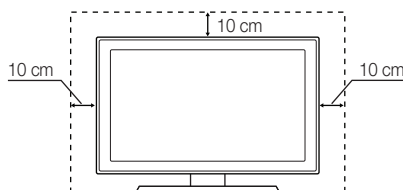

Installation with a wall-mount

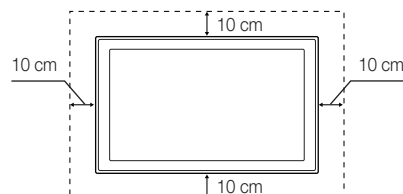

Contents

Getting Started

4

- 4 Accessories
- 5 Viewing the Control Panel
- 6 Viewing the Remote Control
- 7 Connecting to an Antenna
- 7 Plug & Play (Initial Setup)

Connections

8

- 8 Connecting to an AV Device
- 9 Connecting to an Audio Device
- 10 Changing the Input Source

Basic Features

11

- 11 How to Navigate Menus
- 11 Using the **INFO** button (Now & Next guide)
- 11 Planning Your Viewing
- 13 Channel Menu
- 15 Picture Menu
- 17 Sound Menu
- 19 Setup Menu
- 22 Support Menu

Advanced Features

23

- 23 Connecting to a PC
- 24 Network Connection
- 30 Media Play
- 37 Anynet+
- 40 AllShare

Other Information

42

- 42 Analogue Channel Teletext Feature
- 43 Assembling the Cables
- 44 Installing the Wall Mount
- 46 Anti-theft Kensington Lock
- 46 Securing the TV to the wall
- 47 Troubleshooting
- 50 Specifications
- 51 Index
- Warning! Important Safety Instructions
- Wiring the Mains Power Supply Plug (UK Only)
- Warranty Card

Check the Symbol!



This function can be used by pressing the **TOOLS** button on the remote control.





Note



One-Touch Button

Getting Started

Accessories

-  Please make sure the following items are included with your LED TV. If any items are missing, contact your dealer.
-  The items' colours and shapes may vary depending on the models.
-  Cables not included in the package contents can be purchased separately.

- Remote Control & Batteries (AAA x 2)
- Owner's Instructions
- Quick Setup Guide
- Cleaning Cloth
- Power Cord

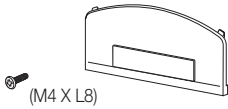

• Blanking Bracket



• Holder-Ring (4EA)



• Holder-Wire (3EA)



• Holder-Wire stand



• Power Cord Clamp

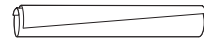

• Cable Tie



• SCART Adapter



• Component Adapter



• AV Adapter

See separate guide for installing the stand.

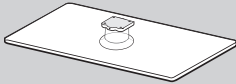

• Stand (1EA)

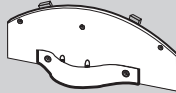

• Guide Stand (1EA)



5EA (M4 X L12)



5EA (M4 X L8)

• Screws (10EA)

-  For best cable connection to this product, be sure to use cables with a maximum thickness as below:

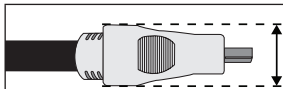







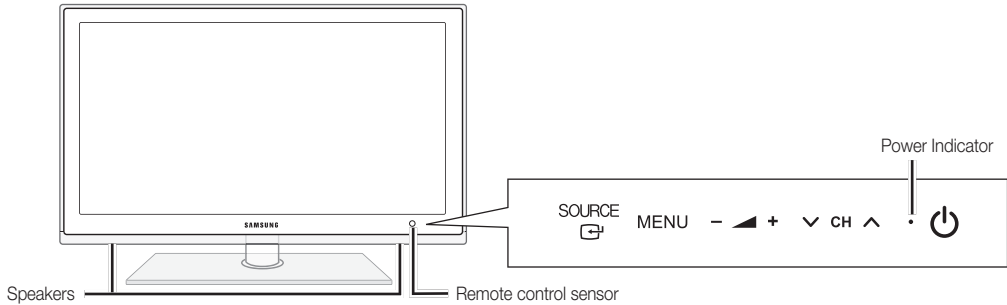





- Maximum thickness - 0.55 inches (14mm)

Viewing the Control Panel

 The product colour and shape may vary depending on the model.



Remote control sensor	Aim the remote control towards this spot on the TV.
SOURCE 	Toggles between all the available input sources. In the on-screen menu, use this button as you would use the ENTER  button on the remote control.
MENU	Displays an on-screen menu, the OSD (on screen display) of your TV's features.
-  +	Adjusts the volume. In the OSD, use the -  + buttons as you would use the  and  buttons on the remote control.
 CH 	Changes the channels. In the OSD, use the  CH  buttons as you would use the  and  buttons on the remote control.
Power Indicator	Blinks and turns off when the power is on and lights up in standby mode.
 (Power)	Turns the TV on or off.

Standby mode

Do not leave your TV in standby mode for long periods of time (when you are away on a holiday, for example). A small amount of electric power is still consumed even when the power button is turned off. It is best to unplug the power cord.

Getting Started

Viewing the Remote Control

 This is a special remote control for the visually impaired persons and has Braille points on the Power, Channel and Volume buttons.

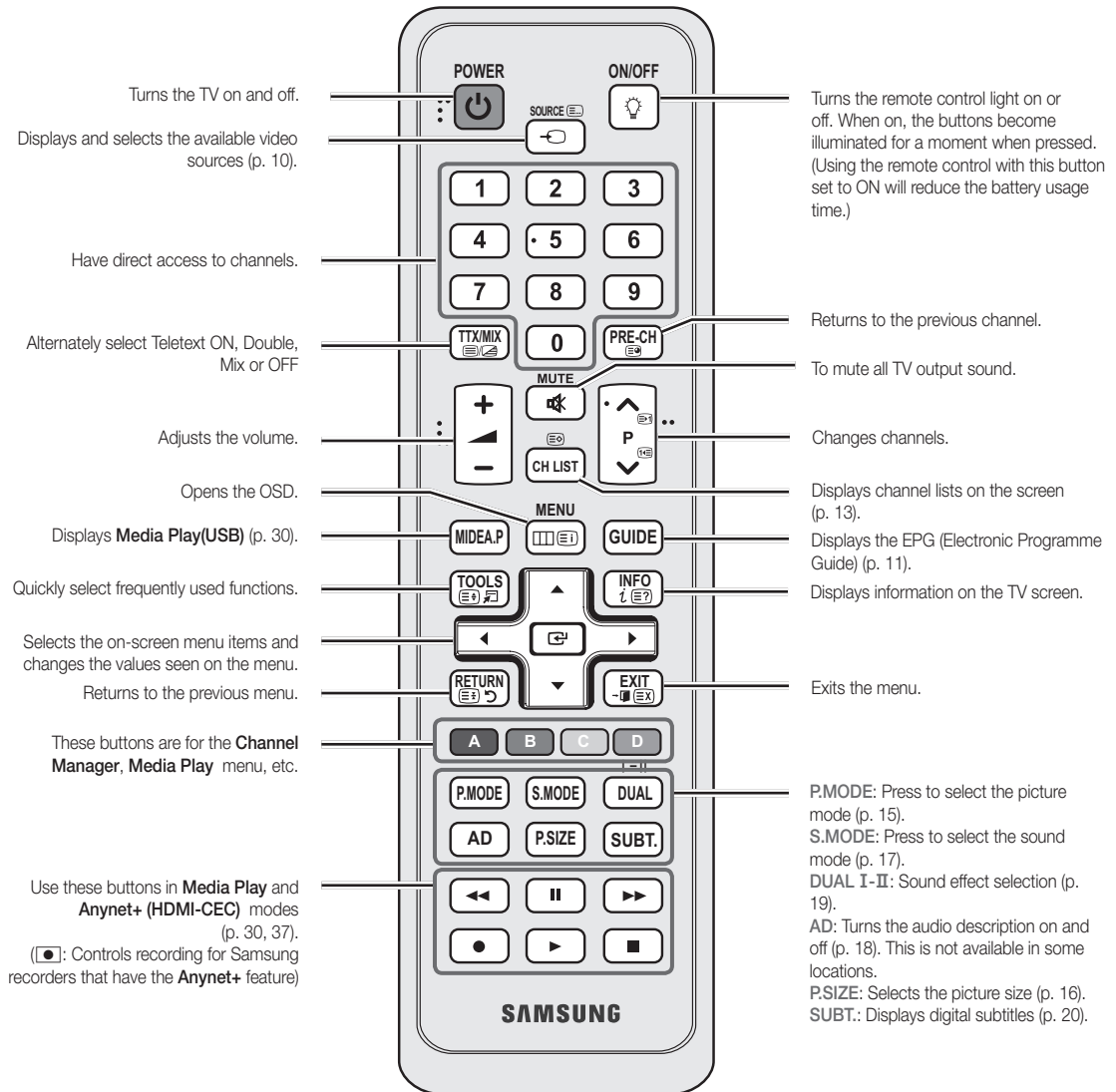

Installing batteries (Battery size: AAA)

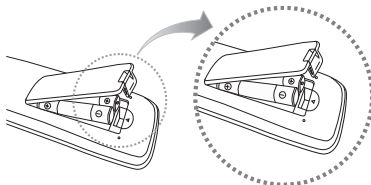

NOTE

- Use the remote control within 23 feet from the TV.
- Bright light may affect the performance of the remote control. Avoid using nearby special fluorescent light or neon signs.
- The colour and shape may vary depending on the model.

Connecting to an Antenna

When the TV is initially powered on, basic settings proceed automatically.

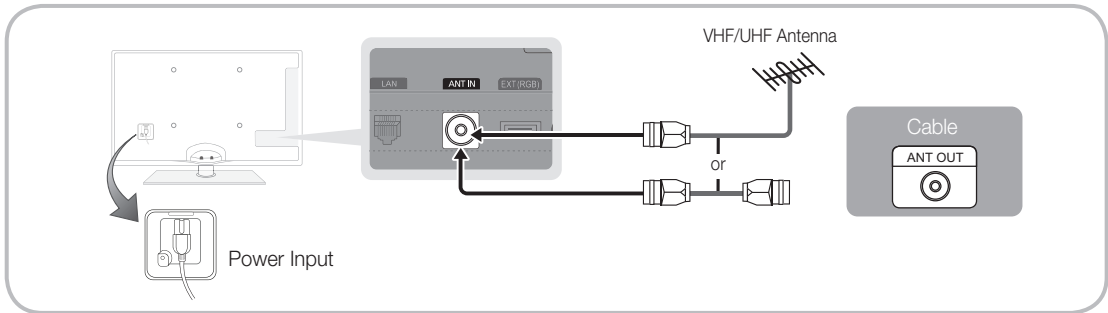

 **Preset:** Connecting the mains and antenna.



Plug & Play (Initial Setup)

When the TV is initially powered on, a sequence of on-screen prompts will assist in configuring basic settings. Press the **POWER** button. **Plug & Play** is available only when the **Input** source is set to TV.

 To return to the previous step, press the Red button.

1	Selecting a language	Press the ▲ or ▼ button, then press the ENTER button. Select the desired OSD (On Screen Display) language.	
2	Selecting Store Demo or Home Use	Press the ◀ or ▶ button, then press the ENTER button. <ul style="list-style-type: none"> Select the Home Use mode. Store Demo Mode is for retail environments. To return the unit's settings from Store Demo to Home Use (standard): Press the volume button on the TV. When you see the volume OSD, press and hold MENU for 5 sec. 	
3	Selecting a country	Press the ▲ or ▼ button, then press the ENTER button. Select the appropriate country. If the desired country does not exist on the menu, select Others .	
4	Selecting an antenna	Press the ▲ or ▼ button, then press the ENTER button. Select Air or Cable .	
5	Selecting a channel	Press the ▲ or ▼ button, then press the ENTER button. Select the channel source to memorise. When setting the antenna source to Cable , a step appears allowing you to assign numerical values (channel frequencies) to the channels. For more information, refer to Channel → Auto Store (p. 13).  Press the ENTER button at any time to interrupt the memorisation process.	
6	Setting the Clock Mode	Set the Clock Mode automatically or manually. Press the ▲ or ▼ button to select Auto , then press the ENTER button.	
7	Viewing the HD Connection Guide .	The connection method for the best HD screen quality is displayed.	
8	Enjoy your TV.	Press the ENTER button.	

If You Want to Reset This Feature...

Select **Setup - Plug & Play** (Initial Setup). Enter your 4 digit PIN number. The default PIN number is "0-0-0-0." If you want to change the PIN number, use the **Change PIN** function.

Connections

Connecting to an AV Device

Using an HDMI or HDMI/DVI cable: HD connection (up to 1080p)

Available devices: DVD, Blu-ray player, HD cable box, HD STB (Set-Top-Box) satellite receiver, cable box, satellite receiver (STB)

HDMI IN 1(DVI), 2, 3, 4, PC/DVI AUDIO IN

- When using an HDMI/DVI cable connection, you must use the **HDMI IN 1(DVI)** jack for video. A DVD, Blu-ray player, HD cable box, HD STB satellite receiver, cable box, or STB satellite receiver may require a DVI-HDMI (DVI to HDMI) cable or DVI-HDMI (DVI to HDMI) adapter. The **PC/DVI AUDIO IN** jack is required for audio.
- If an external device such as a DVD / Blu-ray player / cable box / STB satellite receiver supporting an HDMI version older than 1.3 is connected, the TV may operate abnormally (e.g. no screen display / no sound / annoying flicker / abnormal colour).
- If there is no sound after connecting an HDMI cable, check the HDMI version of the external device. If you suspect the version is older than 1.3, contact the provider of the device to confirm the HDMI version and request an upgrade.
- It is recommended you purchase an HDMI-certified cable. Otherwise, the screen may appear blank or a connection error may occur.

Using a Component (up to 1080p) or Audio/Video (480i only) and Scart Cable

Available devices: DVD, Blu-ray player, cable box, STB satellite receiver, VCR

In Ext. mode, DTV Out supports MPEG SD Video and Audio only.

To obtain the best picture quality, the Component connection is recommended over the A/V connection.

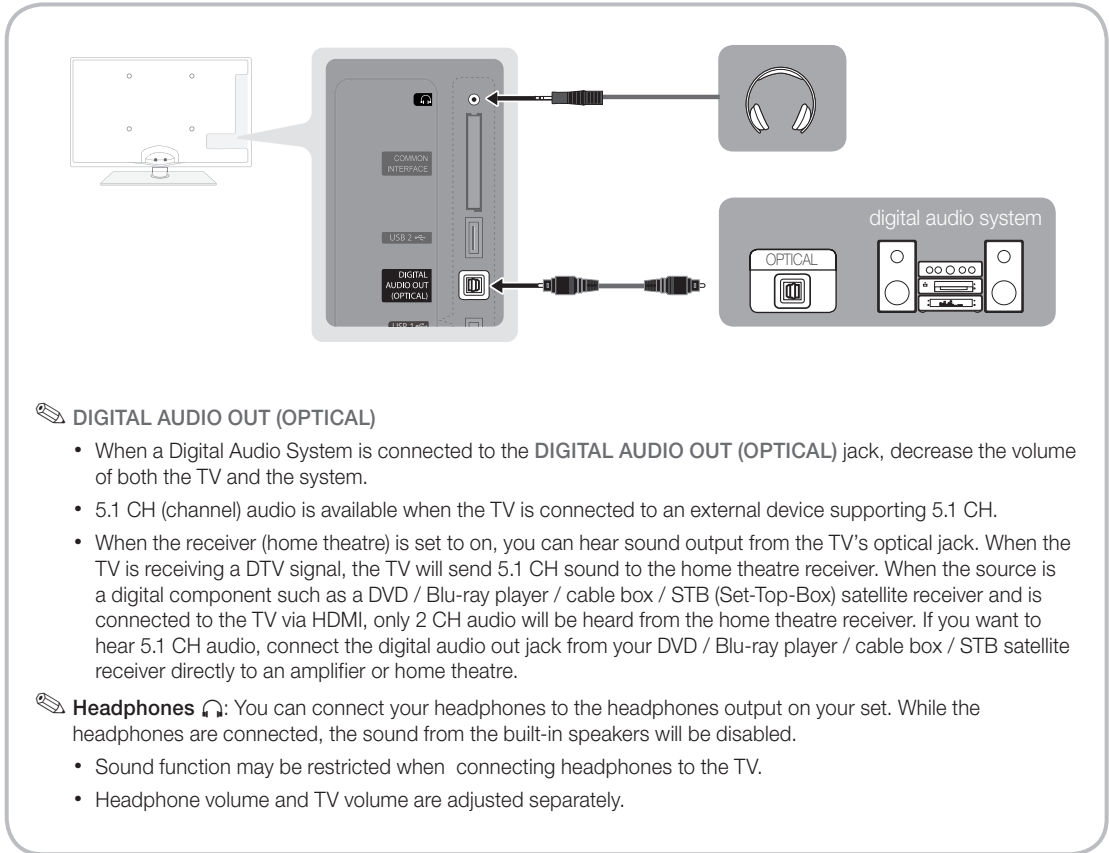

Using an Optical (Digital) or Headphone Cable Connection

Available devices: digital audio system, amplifier, DVD home theatre



DIGITAL AUDIO OUT (OPTICAL)

- When a Digital Audio System is connected to the **DIGITAL AUDIO OUT (OPTICAL)** jack, decrease the volume of both the TV and the system.
- 5.1 CH (channel) audio is available when the TV is connected to an external device supporting 5.1 CH.
- When the receiver (home theatre) is set to on, you can hear sound output from the TV's optical jack. When the TV is receiving a DTV signal, the TV will send 5.1 CH sound to the home theatre receiver. When the source is a digital component such as a DVD / Blu-ray player / cable box / STB (Set-Top-Box) satellite receiver and is connected to the TV via HDMI, only 2 CH audio will be heard from the home theatre receiver. If you want to hear 5.1 CH audio, connect the digital audio out jack from your DVD / Blu-ray player / cable box / STB satellite receiver directly to an amplifier or home theatre.

 **Headphones** : You can connect your headphones to the headphones output on your set. While the headphones are connected, the sound from the built-in speakers will be disabled.

- Sound function may be restricted when connecting headphones to the TV.
- Headphone volume and TV volume are adjusted separately.

Connections

CONNECTIONS COMMON INTERFACE Slot

To watch paid channels, the “CI or CI+ CARD” must be inserted.

- If you don't insert the “CI or CI+ CARD,” some channels will display the message “Scrambled Signal”.
- The pairing information containing a telephone number, the “CI or CI+ CARD” ID the Host ID and other information will be displayed in about 2~3 minutes. If an error message is displayed, please contact your service provider.
- When the configuration of channel information has finished, the message “Updating Completed” is displayed, indicating the channel list is updated.

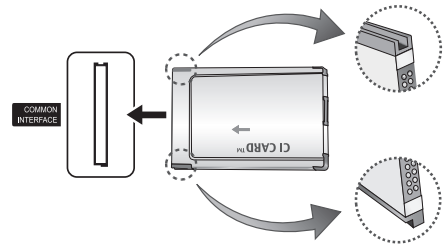

NOTE

- You must obtain a “CI or CI+ CARD” from a local cable service provider.
- When removing the “CI or CI+ CARD”, carefully pull it out with your hands since dropping the “CI or CI+ CARD” may cause damage to it.
- Insert the “CI or CI+ CARD” in the direction marked on the card.
- The location of the **COMMON INTERFACE** slot may be different depending on the model.
- “CI or CI+ CARD” is not supported in some countries and regions; check with your authorized dealer.
- If you have any problems, please contact a service provider.
- Insert the “CI or CI+ CARD” that supports the current antenna settings. The screen will be distorted or will not be seen.

Changing the Input Source

Source List

Use to select TV or an external input sources such as a DVD / Blu-ray player / cable box / STB satellite receiver.

- **TV / Ext. / PC / AV / Component / HDMI1/DVI / HDMI2 / HDMI3 / HDMI4 / USB**

 In the **Source List**, connected inputs will be highlighted.

 **Ext.** and **PC** always stay activated.



Edit Name

- **VCR / DVD / Cable STB / Satellite STB / PVR STB / AV Receiver / Game / Camcorder / PC / DVI PC / DVI Devices / TV / IPTV / Blu-ray / HD DVD / DMA:** Name the device connected to the input jacks to make your input source selection easier.

 When a PC with a resolution of 1920 x 1080 @ 60Hz is connected to the HDMI IN 1(DVI) port, you should set to **DVI PC** mode under **Edit Name**.

 When connecting an HDMI/DVI cable to the HDMI IN 1(DVI) port, you should set to **DVI PC** or **DVI Devices** mode under **Edit Name**.

 If an HDMI cable is connected to the HDMI IN (DVI) port, the audio may not work. In this case, connect to the **PC/DVI AUDIO IN** port.

Basic Features

How to Navigate Menus

Before using the TV, follow the steps below to learn how to navigate the menu and select and adjust different functions.

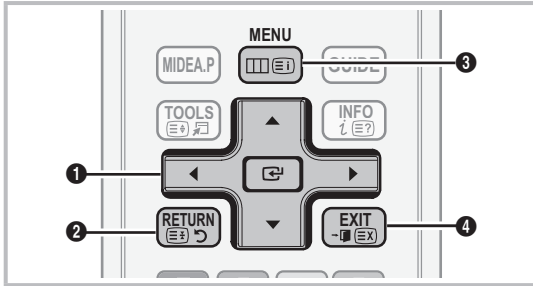

- 1 ENTER / Direction button: Move the cursor and select an item. Confirm the setting.
- 2 RETURN button: Returns to the previous menu.
- 3 MENU button: Displays the main on-screen menu.
- 4 EXIT button: Exits the on-screen menu.

How to Operate the OSD (On Screen Display)

The access step may differ depending on the selected menu.

- | | | |
|----------|-------|--|
| 1 | MENU | The main menu options appear on the screen:
Picture, Sound, Channel, Setup, Input, Application, Support. |
| 2 | ▲ / ▼ | Select an icon with the ▲ or ▼ button. |
| 3 | ENTER | Press ENTER to access the sub-menu. |
| 4 | ▲ / ▼ | Select the desired submenu with the ▲ or ▼ button. |
| 5 | ◀ / ▶ | Adjust the value of an item with the ◀ or ▶ button. The adjustment in the OSD may differ depending on the selected menu. |
| 6 | ENTER | Press ENTER to complete the configuration. |
| 7 | EXIT | Press EXIT. |

Using the INFO button (Now & Next guide)

The display identifies the current channel and the status of certain audio-video settings.



The Now & Next guide shows daily TV programme information for each channel according to the broadcasting time.

- Scroll ◀, ▶ to view information for a desired programme while watching the current channel.
- Scroll ▲, ▼ to view information for other channels. If you want to move to the currently selected channel, press the ENTER button.

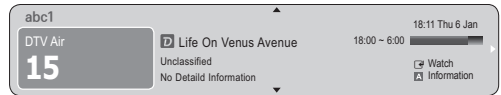

Planning Your Viewing

Guide

The EPG (Electronic Programme Guide) information is provided by broadcasters. Using programme schedules provided by broadcasters, you can specify programmes you want to watch in advance so that the channel automatically changes to the selected programme channel at the specified time. Programme entries may appear blank or out of date depending on a channel status.



Using Channel View

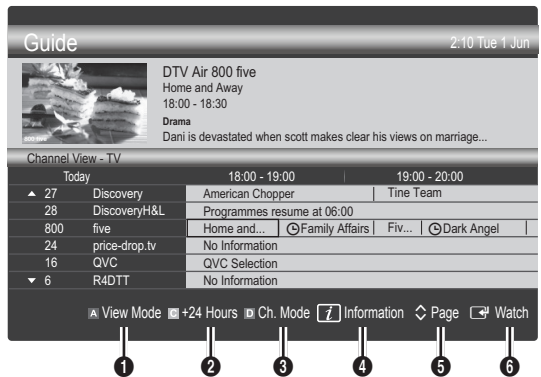

Basic Features

Using Scheduled View

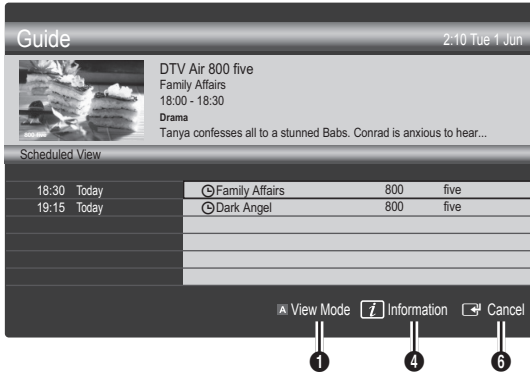

- 1 **Red (View Mode)**: View the list of programmes that are playing now or coming up.
- 2 **Yellow (+24 Hours)**: Viewing the list of programmes to be broadcasted after 24 hours.
- 3 **Blue (Ch. Mode)**: Select the type of channels you want to display on the **Channel View** window. (**All, TV, Radio, Data/Other, My Channel 1~4**)
- 4 **Information**: Displays details of the selected programme.
- 5 **(Page)**: Move to next or previous page.
- 6 **ENTER** button
 - When selecting the current programme, you can watch the selected programme.
 - When selecting the future programme, you can reserve to watch the selected programme. To cancel the schedule, press the **ENTER** button again and select **Cancel Schedules**.

- **Channels**: Shows the channel list according to channel type.
- **My Channels**: Shows the group of the channel.
- **Scheduled**: Shows all the currently reserved programmes.

Using the colour buttons with the **Channel Manager**

- **Red (Antenna)**: Toggle among **Air** or **Cable**.
- **Green (Zoom)**: Enlarges or shrinks a channel number.
- **Yellow (Select)**: Select desired channels and press the Yellow button to set all the selected channels at the same time. The mark appears to the left of the selected channels.
- **Blue (Sort)**: Change the list ordered by channel name or channel number.
- **(Page)**: Move to next or previous page.
- **(Tools)**: Displays the **Channel Manager** option menu. (The options menus may differ depending on the situation.)

Channel Status Display Icons

Icons	Operations
	An analogue channel.
	A channel selected.
	A channel set as a Favourite.
	A programme currently being broadcast.
	A locked channel.
	A reserved programme.

Channel Manager

Delete or set favourites channels and use the programme guide for digital broadcasts. Select a channel in the **Channels, My Channels** or **Scheduled** screen.

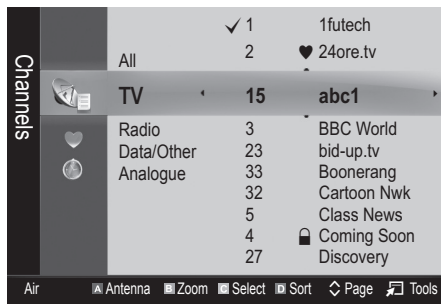

Using Favourite Channels

♥ My Channels

(in **Channel Manager**)

Shows all favourite channels.

- **Edit My Channels** : You can set the selected channels to desired my channels group.

 The “♥” symbol will be displayed and the channel will be set as a my channel.

1. Select a channel and press the **TOOLS** button.
2. Add or delete a channel in the my channel groups you want among 1, 2, 3 and 4.
 - One or more groups can be selected.
3. After you have changed the settings, the channel list for each group can be viewed in my channels.

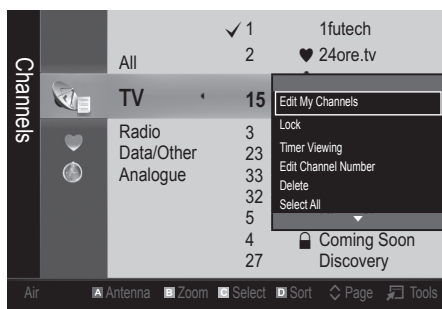

Channel List

You can see all the channels searched.



Channel Menu

Retuning Channels

Antenna (Air / Cable)

Before your television can begin memorizing the available channels, you must specify the type of signal source that is connected to the TV (i.e. an **Air** or a **Cable** system).

Country

The PIN input screen appears. Enter your 4 digit PIN number.

- **Digital Channel**: Change the country for digital channels.
- **Analogue Channel**: Change the country for analogue channels.

Auto Store

Scans for a channel automatically and stores in the TV.

 Automatically allocated programme numbers may not correspond to actual or desired programme numbers. If a channel is locked using the **Child Lock** function, the PIN input window appears.

- **Antenna Source (Air / Cable)** : Select the antenna source to memorise.

- **Channel Source (Digital & Analogue / Digital / Analogue)**: Select the channel source to memorise.

When selecting **Cable** → **Digital & Analogue** or **Digital**: Provide a value to scan for cable channels.

Search Mode (Full / Network / Quick): Scans for all channels with active broadcast stations and stores them in the TV.

 If you select **Quick**, you can set up the **Network**, **Network ID**, **Frequency**, **Modulation** and **Symbol Rate** manually by pressing the button on the remote control.

Network (Auto / Manual): Selects the **Network ID** setting mode among **Auto** or **Manual**.

Network ID: When **Network** is **Manual**, you can set up **Network ID** using the numeric buttons.

Frequency: Displays the frequency for the channel. (differs in each country)

Modulation: Displays available modulation values.

Symbol Rate: Displays available symbol rates.

Manual Store

Scans for a channel manually and stores in the TV.

 If a channel is locked using the **Child Lock** function, the PIN input window appears.

- **Digital Channel**: When scanning has finished, channels are updated in the channel list.

 When selecting **Antenna** → **Air**: **Channel**, **Frequency**, **Bandwidth**

 When selecting **Antenna** → **Cable**: **Frequency**, **Modulation**, **Symbol Rate**

- **Analogue Channel (Programme, Colour System, Sound System, Channel, Search)**: If there is abnormal sound or no sound, reselect the sound standard required.

Basic Features

Channel mode

- **P** (programme mode): When tuning is complete, the broadcasting stations in your area have been assigned to position numbers from P0 to P99. You can select a channel by entering the position number in this mode.
- **C** (aerial channel mode) / **S** (cable channel mode): These two modes allow you to select a channel by entering the assigned number for each aerial broadcasting station or cable channel.

Editing Channels

Channel Manager Option Menu

(in Channel Manager)

1. Select a channel and press the **TOOLS** button.
 2. Edit the channel name or number using the **Edit Channel Name** or **Edit Channel Number** menu.
- **Edit Channel Name** (analogue channels only): Assign your own channel name.
 - **Edit Channel Number** (digital channels only): Edit the number by pressing the number buttons desired.

Other Features

Cable Search Option

(depending on the country)

Sets additional search options such as the frequency and symbol rate for a cable network search.

- **Freq.Start / Freq.Stop**: Set the start or stop frequency (differs in each country).
- **Modulation**: Displays available modulation values.
- **Symbol Rate**: Displays available symbol rates.

Channel Manager

Channel Manager Option Menu

Set each channel using the **Channel Manager** menu options (**Lock / Unlock**, **Timer Viewing**, **Sort**, **Delete**, **Select All / Deselect All**). Option menu items may differ depending on the channel status.

1. Select a channel and press the **TOOLS** button.
2. Select a function and change its settings.

- **Lock / Unlock**: Lock a channel so that the channel cannot be selected and viewed.

NOTE

- This function is available only when the **Child Lock** is set to **On**.
 - The PIN input screen appears. Enter your 4-digit PIN, the default of which is "0-0-0-0". Change the PIN using the **Change PIN** option.
- **Timer Viewing**: You can set a desired channel to be displayed automatically at the reserved time. Set the current time first to use this function.
 When a digital channel is selected, press the ► button to view the digital Programme.
 - **Sort** (analogue channels only): This operation allows you to change the programme numbers of the stored channels. This operation may be necessary after using the auto store.
 - **Delete**: You can delete a channel to display the channels you want.
 - **Select All / Deselect All**: Select all the channels or deselect all the selected channels in the channel manager.

Channel List Transfer

The PIN input screen appears. Enter your 4 digit PIN number. Imports or exports the channel map. You should connect a USB storage to use this function.

- **Import from USB**: Import channel list from USB.
- **Export to USB**: Export channel list to USB. this function is available when USB is connected.

Scheduled

(in Channel Manager)

You can view, modify or delete a show you have reserved to watch.

- **Change Info**: Change a show you have reserved to watch.
- **Cancel Schedules**: Cancel a show you have reserved to watch.
- **Information**: Display a show you have reserved to watch. (You can also change the reservation information.)
- **Select All / Deselect All**: Select or deselect all reserved programmes.

Fine Tune

(analogue channels only)

If the signal is weak or distorted, fine tune the channel manually.

 Fine tuned channels are marked with an asterisk "***".

 To reset the fine-tuning, select **Reset**.

Picture Menu

Changing the Preset Picture Mode

Mode

Select your preferred picture type.

- **Dynamic:** Suitable for a bright room.
- **Standard:** Suitable for a normal environment.
- **Natural:** Suitable for reducing eye strain.
 - ✎ **Natural** is not available in PC mode.
- **Movie:** Suitable for watching movies in a dark room.



Adjusting Picture Settings

Backlight / Contrast / Brightness / Sharpness / Colour / Tint (G/R)

Your television has several setting options for picture quality control.

NOTE

- In analogue **TV**, **Ext.**, **AV** modes of the PAL system, the **Tint (G/R)** function is not available.
- In PC mode, you can only make changes to **Backlight**, **Contrast** and **Brightness**.
- Settings can be adjusted and stored for each external device connected to the TV.

Economical Solutions

Eco Solution

- **Energy Saving (Off / Low / Medium / High / Picture Off / Auto)** **TOOLS**: This adjusts the brightness of the TV in order to reduce power consumption. If you select **Picture Off**, the screen is turned off, but the sound remains on. Press any button except volume button to turn on the screen.
 - **Eco Sensor (Off / On):** To enhance your power savings; the picture settings will automatically adapt to the light in the room.
 - ✎ If you adjust the **Backlight**, the **Eco Sensor** will be set to **Off**.
- Min Backlight:** When **Eco sensor** is **On**, the minimum screen brightness can be adjusted manually.
- ✎ If **Eco Sensor** is **On**, the display brightness may change (become slightly darker or brighter) depending on the surrounding light intensity.

- **No-Signal Power Off (Off / 15 min / 30 min / 60 min):** To avoid unnecessary energy consumption, set how long you want the TV to remain on if it's not receiving a signal.
 - ✎ Disabled when the PC is in power saving mode.

Changing the Picture Options

Advanced Settings

(available in **Standard / Movie** mode)

You can adjust the detailed setting for the screen including colour and contrast.

- ✎ In PC mode, you can only make changes to **Dynamic Contrast**, **Gamma**, **White Balance** and **LED Motion Plus**.

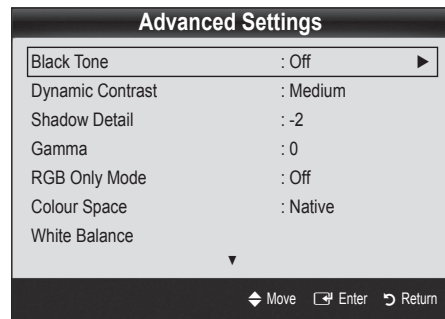

- **Black Tone (Off / Dark / Darker / Darkest):** Select the black level to adjust the screen depth.
- **Dynamic Contrast (Off / Low / Medium / High):** Adjust the screen contrast.
- **Shadow Detail (-2~+2):** Increase the brightness of dark images.
- **Gamma:** Adjust the primary colour intensity.
- **RGB Only Mode (Off / Red / Green / Blue):** You can adjust **Colour** or **Tint (G/R)** of **Red**, **Green** or **Blue** for the picture from an external device (DVD player, home theatre, etc.).

Basic Features

- **Colour Space (Auto / Native):** Adjust the range of colours available to create the image.
- **White Balance:** Adjust the colour temperature for a more natural picture.
 - R-Offset / G-Offset / B-Offset:** Adjust each colour's (red, green, blue) darkness.
 - R-Gain / G-Gain / B-Gain:** Adjust each colour's (red, green, blue) brightness.
 - Reset:** Resets the **White Balance** to its default settings.
- **Flesh Tone:** Emphasize pink "Flesh Tone."
- **Edge Enhancement (Off / On):** Emphasize object boundaries.
- **LED Motion Plus (Off / On):** Removes drag from fast scenes with a lot of movement to provide a clear picture.

Wide Zoom: Magnifies the picture size more than 4:3.

 Adjusts the **Position** by using **▲**, **▼** buttons.

Zoom: Magnifies the 16:9 wide pictures vertically to fit the screen size.

 Adjusts the **Position** or **Size** by using **▲**, **▼** button.

4:3: The default setting for a movie or normal broadcasting.

 Do not watch in 4:3 format for a long time. Traces of borders displayed on the left, right and centre of the screen may cause image retention (screen burn) which are not covered by the warranty.

Screen Fit: Displays the full image without any cut-off when HDMI (720p / 1080i / 1080p) or Component (1080i / 1080p) signals are inputted.

NOTE

- Depending on the input source, the picture size options may vary.
- The available items may differ depending on the selected mode.
- In PC mode, only **16:9** and **4:3** modes can be adjusted.
- Settings can be adjusted and stored for each external device connected to an input on the TV.
- After selecting **Screen Fit** in **HDMI** (1080i / 1080p) or **Component** (1080i / 1080p) mode: Adjusts the **Position** or **Size** by using **▲**, **▼**, **◀**, **▶** button.
- If you use the **Screen Fit** function with HDMI 720p input, 1 line will be cut at the top, bottom, left and right as in the overscan function.

Picture Options

 In PC mode, you can only make changes to the **Colour Tone**, **Size** and **Auto Protection Time**.

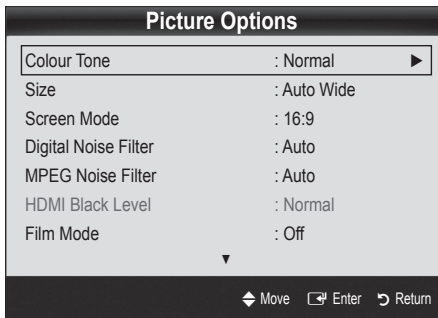

- **Colour Tone (Cool / Normal / Warm1 / Warm2)**

 **Warm1** or **Warm2** will be deactivated when the picture mode is **Dynamic**.

 Settings can be adjusted and stored for each external device connected to an input on the TV.

- **Size:** Your cable box/satellite receiver may have its own set of screen sizes as well. However, we highly recommend you use 16:9 mode most of the time.

Auto Wide: Automatically adjusts the picture size to the 16:9 aspect ratio.

16:9: Adjusts the picture size to 16:9 for DVDs or wide broadcasting.



- **Screen Mode (16:9 / Wide Zoom / Zoom / 4:3):**



Available only when picture size is set to **Auto Wide**. You can determine the desired picture size at the 4:3 WSS (Wide Screen Service) size or the original size. Each European country requires different picture size.

 Not available in PC, Component or HDMI mode.

- **Digital Noise Filter (Off / Low / Medium / High / Auto / Auto Visualisation):** When the broadcast signal is weak, some static and ghosting may appear. Select one of the options until the best picture is displayed.

Auto Visualisation: When changing analogue channels, displays the intensity of the current signal and defines the screen noise filter.

 Only available for analogue channels.

- **MPEG Noise Filter (Off / Low / Medium / High / Auto):** Reduces MPEG noise to provide improved picture quality.
- **HDMI Black Level (Normal / Low):** Selects the black level on the screen to adjust the screen depth.
 -  Available only in HDMI mode (RGB signals).
- **Film Mode (Off / Auto1 / Auto2):** Sets the TV to automatically sense and process film signals from all sources and adjust the picture for optimum quality.
 -  Available in TV, AV, COMPONENT (480i / 1080i) and HDMI (480i / 1080i).
- **Auto Protection Time (2 hours / 4 hours / 8 hours / 10 hours / Off):** If the screen remains idle with a still image for a certain period of time defined by the user, the screen saver is activated to prevent the formation of ghost images on the screen.

Picture Reset (OK / Cancel)

Resets your current picture mode to its default settings.

Setting up the TV with Your PC

Set the input source to PC.

Auto Adjustment

Adjust frequency values/positions and fine tune the settings automatically.

Not available when connecting with an HDMI/DVI cable.

Screen

- **Coarse / Fine:** Removes or reduces picture noise. If the noise is not removed by Fine-tuning alone, then adjust the frequency as best as possible (**Coarse**) and Fine-tune again. After the noise has been reduced, readjust the picture so that it is aligned to the centre of screen.
- **Position:** Adjust the PC screen position with direction button (▲ / ▼ / ◀ / ▶).
- **Image Reset:** Resets the image to default settings.

Using Your TV as a Computer (PC) Display

Setting Up Your PC Software (Based on Windows XP)

Depending on the version of Windows and the video card, the actual screens on your PC may differ in which case the same basic set-up information will almost always be applied. (If not, contact your computer manufacturer or Samsung Dealer.)

1. Click on "Control Panel" on the Windows start menu.
2. Click on "Appearance and Themes" in the "Control Panel" window and a display dialog-box will appear.
3. Click on "Display" and a display dialog box will appear.
4. Navigate to the "Settings" tab on the display dialog-box.
 - The correct size setting (resolution) [Optimum: 1920 X 1080 pixels]
 - If a vertical-frequency option exists on your display settings dialog box, the correct value is "60" or "60 Hz". Otherwise, just click "OK" and exit the dialog box.

Sound Menu

Changing the Preset Sound Mode

Mode

- **Standard:** Selects the normal sound mode.
- **Music:** Emphasizes music over voices.
- **Movie:** Provides the best sound for movies.
- **Clear Voice:** Emphasizes voices over other sounds.
- **Amplify:** Increase the intensity of high-frequency sound to allow a better listening experience for the hearing impaired.



Basic Features

Adjusting Sound Settings

Equalizer

Adjusts the sound mode (standard sound mode only).

- **Balance L/R:** Adjusts the balance between the right and left speaker.
- **100Hz / 300Hz / 1kHz / 3kHz / 10kHz** (Bandwidth Adjustment): Adjusts the level of specific bandwidth frequencies.
- **Reset:** Resets the equalizer to its default settings.

Sound Systems, Etc.

Virtual Surround (Off / On)

(standard sound mode only)

This function provides a virtual 5.1 channel surround sound experience through a pair of speakers using HRTF (Head Related Transfer Function) technology.

Dialog Clarity (Off / On)

(standard sound mode only)

This function allows you to increase the intensity of a voice over background music or sound effects so that dialog can be heard more clearly.

Audio Language

(digital channels only)

Change the default value for audio languages.

-  The available language may differ depending on the broadcast.

Audio Format

(digital channels only)

When sound is emitted from both the main speaker and the audio receiver, a sound echo may occur due to the decoding speed difference between the main speaker and the audio receiver. In this case, use the TV Speaker function.

-  **Audio Format** option may differ depending on the broadcast. 5.1ch Dolby digital sound is only available when connecting an external speaker through an optical cable.

Audio Description

(not available in all locations) (digital channels only)

This function handles the Audio Stream for the **AD** (Audio Description) which is sent along with the Main audio from the broadcaster.

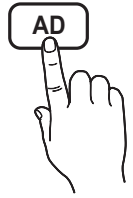

- **Audio Description (Off / On):** Turn the audio description function on or off.
- **Volume:** Adjust the audio description volume.





Auto Volume (Off / Normal / Night)

To equalize the volume level on each channel, set to **Normal**.

- **Night:** This mode provides an improved sound experience compared to **Normal** mode, making almost no noise. It is useful at night.



Speaker Select (External Speaker / TV Speaker)

A sound echo may occur due to a difference in decoding speed between the main speaker and the audio receiver. In this case, set the TV to **External Speaker**.

-  When **Speaker Select** is set to **External Speaker**, the volume and MUTE buttons will not operate and the sound settings will be limited.
-  When **Speaker Select** is set to **External Speaker**
 - **TV Speaker: Off, External Speaker: On**
-  When **Speaker Select** is set to **TV Speaker**
 - **TV Speaker: On, External Speaker: On**
-  If there is no video signal, both speakers will be mute.

Additional Setting

(digital channels only)

- **DTV Audio Level (MPEG / HE-AAC):** This function allows you to reduce the disparity of a voice signal (which is one of the signals received during a digital TV broadcast) to a desired level.
 -  According to the type of broadcast signal, **MPEG / HE-AAC** can be adjusted between -10dB and 0dB.
 -  To increase or decrease the volume, adjust between the range 0 and -10 respectively.

- **SPDIF Output:** SPDIF (Sony Philips Digital InterFace) is used to provide digital sound, reducing interference going to speakers and various digital devices such as a DVD player.

Audio Format: During the reception of a digital TV broadcast, you can select the Digital Audio output (SPDIF) format from the options **PCM** or **Dolby Digital**.

Audio Delay: Correct audio-video sync problems, when watching TV or video, and when listening to digital audio output using an external device such as an AV receiver (0ms ~ 250ms).

- **Dolby Digital Comp (Line / RF):** This function minimizes signal disparity between a dolby digital signal and a voice signal (i.e. MPEG Audio, HE-AAC, ATV Sound).

 Select **Line** to obtain dynamic sound, and **RF** to reduce the difference between loud and soft sounds at night time.

Line: Set the output level for signals greater or less than -31dB (reference) to either -20dB or -31dB.

RF: Set the output level for signals greater or less than -20dB (reference) to either -10dB or -20dB.

Sound Reset (OK / Cancel)

Reset all sound settings to the factory defaults.

Selecting the Sound Mode

When you set to **Dual I-II**, the current sound mode is displayed on the screen.



	Audio Type	Dual I-II	Default
A2 Stereo	Mono	Mono	Automatic change
	Stereo	Stereo ↔ Mono	
	Dual	Dual I ↔ Dual II	Dual I
NICAM Stereo	Mono	Mono	Automatic change
	Stereo	Mono ↔ Stereo	
	Dual	Mono ↔ Dual I ↙ Dual II ↘	Dual I

 If the stereo signal is weak and an automatic switching, occurs, then switch to the mono.

 Only activated in stereo sound signal.

 Only available when the **Input** source is set to **TV**.

Setup Menu

Setting the Time

Time

- **Clock:** Setting the clock is for using various timer features of the TV.



The current time will appear every time you press the **INFO** button.



If you disconnect the power cord, you have to set the clock again.

Clock Mode (Auto / Manual)



Depending on the broadcast station and signal, the auto time set up may not be correct. In this case, set the time manually.



The antenna must be connected in order to set the time automatically.

Clock Set: Set the **Day**, **Month**, **Year**, **Hour** and **Minute** manually.



Available only when **Clock Mode** is set to **Manual**.

Using the Sleep Timer

- **Sleep Timer** : Automatically shuts off the TV after a preset period of time. (30, 60, 90, 120, 150 and 180 minutes).



To cancel **Sleep Timer**, select **Off**.

Setting the On / Off Timer

- **Timer 1 / Timer 2 / Timer 3:** Three different on / off timer settings can be made. You must set the clock first.

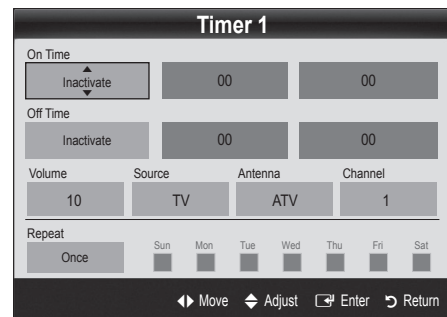

Basic Features

On Time / Off Time: Set the hour, minute, and activate / inactivate. (To activate timer with the setting you've chosen, set to **Activate**.)

Volume: Set the desired volume level.

Source: Select **TV** or **USB** content to be played when the TV is turned on automatically. (**USB** can be selected only when a USB device is connected to the TV)

Antenna (when the **Source** is set to **TV**): Select **ATV** or **DTV**.

Channel (when the **Source** is set to **TV**): Select the desired channel.

Contents (when the **Source** is set to **USB**): Select a folder in the USB device containing music or photo files to be played when the TV is turned on automatically.

 If there is no music file on the USB device or the folder containing a music file is not selected, the Timer function does not operate correctly.

 When there is only one photo file in the USB device, the Slide Show will not play.

 If a folder name is too long, the folder cannot be selected.

 Each USB you use is assigned its own folder. When using more than one of the same type of USB, make sure the folders assigned to each USB have different names.

Repeat: Select **Once**, **Everyday**, **Mon~Fri**, **Mon~Sat**, **Sat~Sun** or **Manual** to set at your convenience. If you select **Manual**, you can set up the day you want to activate the timer.

 The mark indicates the day is selected.

 **Auto Power Off** (available only when the TV is turned on by Timer): The TV will be automatically turned off after 3 hours of being left idle to prevent overheating.

Locking Programmes

Security

 The PIN input screen appears before the setup screen.

 Enter your 4-digit PIN, the default of which is "0-0-0-0". Change the PIN using the **Change PIN** option.

■ **Child Lock (Off / On):** Lock channels in **Channel Manager**, to prevent unauthorized users, such as children, from watching unsuitable programme.

 Available only when the **Input** source is set to **TV**.

■ **Parental Lock** (depending on the country): Prevent unauthorized users, such as children, from watching unsuitable programme with a user-defined 4-digit PIN code. If the selected channel is locked, the "🔒" symbol will be displayed.

Allow All: Unlock All TV ratings.

■ **Change PIN:** Change your personal ID number required to set up the TV.

 If you forget the PIN code, press the remote control buttons in the following sequence, which resets the PIN to "0-0-0-0": **POWER** (off) → **MUTE** → 8 → 2 → 4 → **POWER** (on).

Other Features

Language

■ **Menu Language:** Set the menu language.

■ **Teletext Language:** Set a desired language for teletext.

 English is the default in cases where the selected language is unavailable in the broadcast.

■ **Preference (Primary Audio Language / Secondary Audio Language / Primary Subtitle Language / Secondary Subtitle Language / Primary Teletext Language / Secondary Teletext Language):** Select a language, which will be the default language when a channel is selected.

Subtitle

Use this menu to set the **Subtitle** mode.

■ **Subtitle (Off / On):** Switches subtitles on or off.

■ **Mode (Normal / Hearing Impaired):** Sets the subtitle mode.

■ **Subtitle Language:** Sets the subtitle language.

 If the programme you are watching does not support the **Hearing Impaired** function, **Normal** automatically activates even if the **Hearing Impaired** mode is selected.

 English is the default in cases where the selected language is unavailable in the broadcast.



Digital Text (Disable / Enable)

If the programme broadcasts with digital text, this feature is enabled.

Network (Network Type / Network Setup / Network Test)

For details on setting up options, refer to the "Network Connection" instructions (p. 24).

General

- **Game Mode (Off / On):** When connecting to a game console such as PlayStation™ or Xbox™, you can enjoy a more realistic gaming experience by selecting game mode.

NOTE

- Precautions and limitations for game mode
 - To disconnect the game console and connect another external device, set **Game Mode** to **Off** in the setup menu.
 - If you display the TV menu in **Game Mode**, the screen shakes slightly.
- **Game Mode** is not available when the input source is set to TV or PC.
- After connecting the game console, set **Game Mode** to **On**. Unfortunately, you may notice reduced picture quality.
- If **Game Mode** is **On**:
 - **Picture** mode is set to **Standard** and **Sound** mode is set to **Movie**.
 - **Equalizer** is not available.

- **Menu Transparency (Bright / Dark):** Set the Transparency of the menu.

- **Melody (Off / Low / Medium / High):** Set so that a melody plays when the TV is turned on or off.

Common Interface

- **CI Menu:** This enables the user to select from the CAM-provided menu. Select the CI Menu based on the menu PC Card.

- **Application Info:** View information on the CAM inserted into the CI slot and on the “CI or CI+ CARD” which is inserted into the CAM. You can install the CAM anytime whether the TV is on or off.

1. Purchase a CI CAM module at your nearest dealer or by phone.
2. Firmly insert the “CI or CI+ CARD” into the CAM in the direction of the arrow.
3. Insert the CAM with the “CI or CI+ CARD” into the common interface slot, in the direction of the arrow so that it aligns parallel with the slot.
4. Check if you can see a picture on a scrambled signal channel.

Picture In Picture (PIP)







PIP

You can watch the TV tuner and one external video source simultaneously. **PIP** (Picture-in-Picture) does not function in the same mode.

NOTE

- For PIP sound, refer to the **Sound Select** instructions.
- If you turn the TV off while watching in **PIP** mode, the PIP window will disappear.
- You may notice that the picture in the PIP window becomes slightly unnatural when you use the main screen to view a game or karaoke.
- PIP settings

Main picture	Sub picture
Component, HDMI1/DVI, HDMI2, HDMI3, HDMI4, PC	TV

- **PIP (Off / On):** Activate or deactivate the PIP function.
- **Channel:** Select the channel for the sub-screen.
- **Size** ( / ): Select a size for the sub-picture.
- **Position** ( /  /  / ): Select a position for the sub-picture.
- **Sound Select (Main / Sub):** You can choose the desired sound (**Main / Sub**) in **PIP** mode.

Basic Features

Support Menu

Self Diagnosis

- Self Diagnostic might take few seconds, this is part of the normal operation of the TV.
- Picture Test (Yes / No):** Use to check for picture problems.
- Sound Test (Yes / No):** Use the built-in melody sound to check for sound problems.
 - If you hear no sound from the TV's speakers, before performing the sound test, make sure **Speaker Select** is set to **TV Speaker** in the **Sound** menu.
 - The melody will be heard during the test even if **Speaker Select** is set to **External Speaker** or the sound is muted by pressing the **MUTE** button.
- Signal Information:** (digital channels only) HDTV channel's reception quality is either perfect or the channels are unavailable. Adjust your antenna to increase signal strength.
- Troubleshooting:** If the TV seems to have a problem, refer to this description.
 - If none of these troubleshooting tips apply, contact the Samsung customer service centre.

Software Upgrade

Software Upgrade can be performed via a broadcasting signal or by network connection or downloading the latest firmware from "www.samsung.com," to a USB memory device.

Current Version the software already installed in the TV.

Software is represented as "Year/Month/Day_Version".

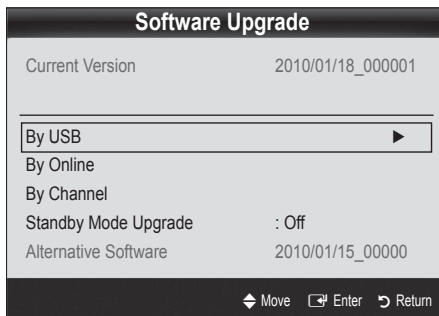

Installing the Latest Version

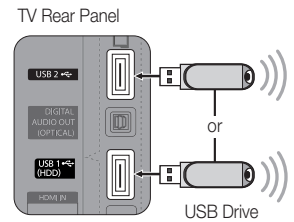
- By USB:** Insert a USB drive containing the firmware upgrade file, downloaded from "www.samsung.com," into the TV. Please be careful not to disconnect the power or remove the USB drive until upgrades are complete. The TV will be turned off and on automatically after completing the firmware upgrade. When software is upgraded, video and audio settings you have made will return to their default settings. We advise you to write down your settings so that you can easily reset them after the upgrade.
- By Online:** Upgrade the software using the Internet.
 - First, configure your network. For detailed procedures on using the Network Setup, refer to the "Network Connection" instructions.
 - If the internet connection doesn't operate properly, the connection may be broken. Please retry downloading. If the problem persists, download by USB and upgrade.
- By Channel:** Upgrade the software using the broadcasting signal.
 - If the function is selected during the software transmission period, software will be automatically searched and downloaded.
 - The time required to download the software is determined by the signal status.
- Standby Mode Upgrade:** A manual upgrade will be automatically performed at selected time. Since the power of the unit is turned on internally, the screen may be turned on slightly for the LED product. This phenomenon may continue for more than 1 hour until the software upgrade is complete.
- Alternative Software (backup):** Displays the software version downloaded through **By Online**. During the software upgrading, When the Upgrade will discontinue from last step, this function be activated.

HD Connection Guide

Refer to this information when connecting external devices to the TV.

Contact Samsung

View this information when your TV does not work properly or when you want to upgrade the software. You can find information regarding our call centres, and how to download products and software.

Connecting to a PC

Using an HDMI/DVI Cable / a D-sub Cable

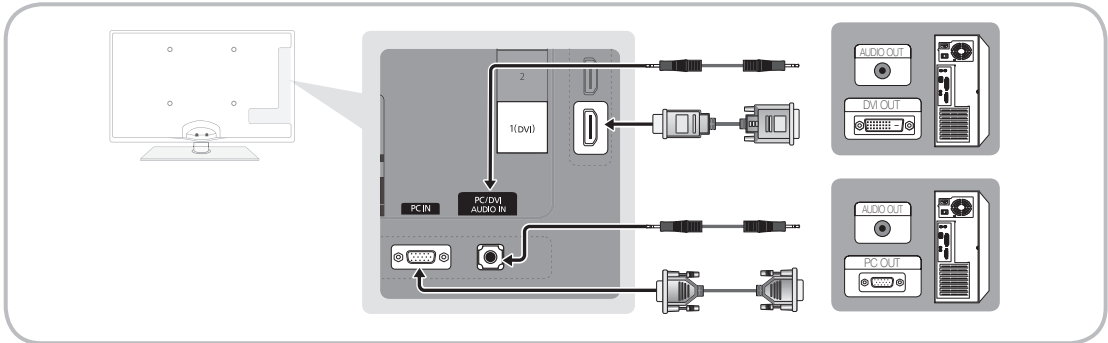

Display Modes (D-Sub and HDMI/DVI Input)

Optimal resolution is 1920 X 1080 @ 60 Hz.

Mode	Resolution	Horizontal Frequency (kHz)	Vertical Frequency (Hz)	Pixel Clock Frequency (MHz)	Sync Polarity (H / V)
IBM	640 x 350	31.469	70.086	25.175	+/-
	720 x 400	31.469	70.087	28.322	-/+
MAC	640 x 480	35.000	66.667	30.240	-/-
	832 x 624	49.726	74.551	57.284	-/-
	1152 x 870	68.681	75.062	100.000	-/-
VESA CVT	720 x 576	35.910	59.950	32.750	-/+
	1152 x 864	53.783	59.959	81.750	-/+
	1280 x 720	56.456	74.777	95.750	-/+
	1280 x 960	75.231	74.857	130.000	-/+
VESA DMT	640 x 480	31.469	59.940	25.175	-/-
	640 x 480	37.861	72.809	31.500	-/-
	640 x 480	37.500	75.000	31.500	-/-
	800 x 600	37.879	60.317	40.000	+/+
	800 x 600	48.077	72.188	50.000	+/+
	800 x 600	46.875	75.000	49.500	+/+
	1024 x 768	48.363	60.004	65.000	-/-
	1024 x 768	56.476	70.069	75.000	-/-
	1024 x 768	60.023	75.029	78.750	+/+
	1152 x 864	67.500	75.000	108.000	+/+
	1280 x 1024	63.981	60.020	108.000	+/+
	1280 x 1024	79.976	75.025	135.000	+/+
	1280 x 720	45.000	60.000	74.250	+/+
	1280 x 800	49.702	59.810	83.500	-/+
	1280 x 800	62.795	74.934	106.500	-/+
	1280 x 960	60.000	60.000	108.000	+/+
1360 x 768	47.712	60.015	85.500	+/+	
1440 x 900	55.935	59.887	106.500	-/+	
1440 x 900	70.635	74.984	136.750	-/+	
1680 x 1050	65.290	59.954	146.250	-/+	
VESA GTF	1280 x 720	52.500	70.000	89.040	-/+
	1280 x 1024	74.620	70.000	128.943	-/-
VESA DMT / DTV CEA	1920 x 1080p	67.500	60.000	148.500	+/+

NOTE

- For HDMI/DVI cable connection, you must use the HDMI IN 1(DVI) jack.
- The interlace mode is not supported.
- The set might operate abnormally if a non-standard video format is selected.
- Separate and Composite modes are supported. SOG(Sync On Green) is not supported.

Advanced Features

Network Connection

You can set up your TV so that it can access the Internet through your local area network (LAN) using a wired or wireless connection.

Connecting to a Wired Network

You can attach your TV to your LAN using cable in three ways:

- You can attach your TV to your LAN by connecting the LAN port on the back of your TV to an external modem using a Cat 5 cable. See the diagram below.

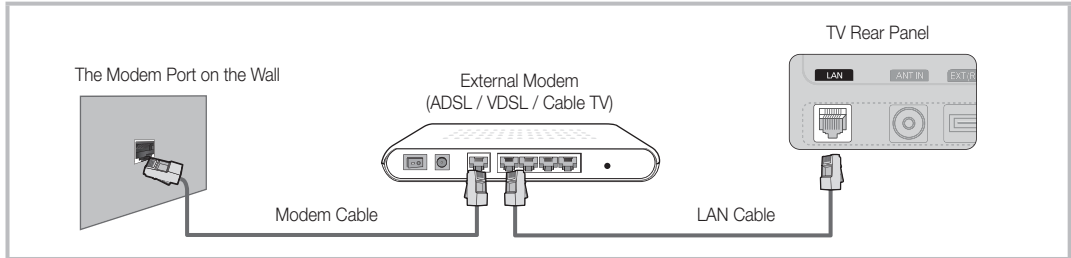

- You can attach your TV to your LAN by connecting the LAN port on the back of your TV to a IP Sharer which is connected to an external modem. Use Cat 5 cable for the connection. See the diagram below.

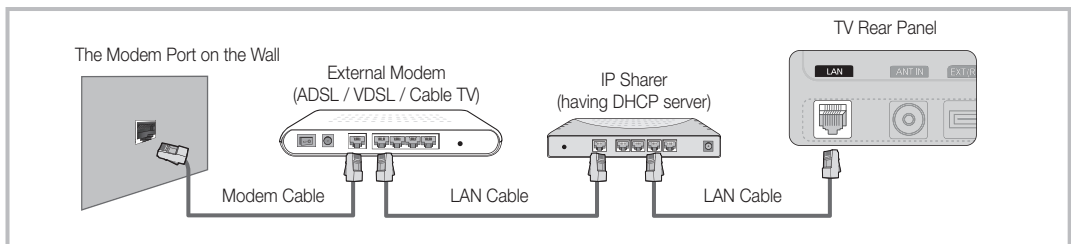

- Depending on how your network is configured, you may be able to attach your TV to your LAN by connecting the LAN port on the back of your TV directly to a network wall outlet using a Cat 5 cable. See the diagram below. Note that the wall outlet is attached to a modem or router elsewhere in your house.

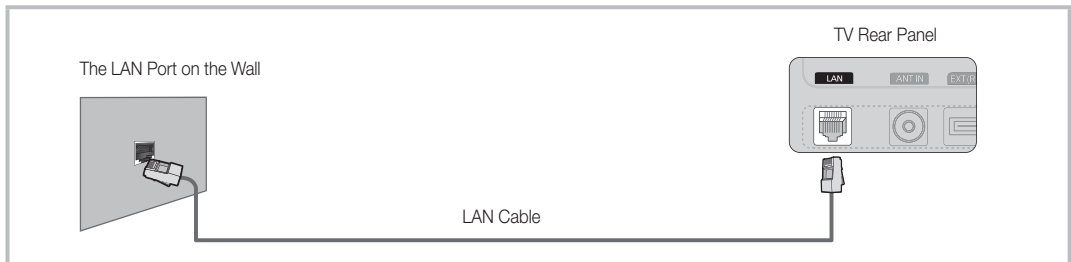

If you have a Dynamic Network, you should use an ADSL modem or router that supports Dynamic Host Configuration Protocol (DHCP). Modems and routers that support DHCP automatically provide the IP address, subnet mask, gateway, and DNS values your TV needs to access the Internet so you don't have to enter them manually. Most home networks are Dynamic Networks.

Some networks require a Static IP address. If your network requires a Static IP address, you must enter the IP address, subnet mask, gateway, and DNS values manually on your TV's Cable Setup Screen when you set up the network connection. To get the IP address, subnet mask, gateway, and DNS values, contact your Internet Service Provider (ISP). If you have a Windows computer, you can also get these values through your computer.

- You can use ADSL modems that support DHCP if your network requires a Static IP address. ADSL modems that support DHCP also let you use Static IP addresses.

Network Setup (Auto)

Use the Automatic **Network Setup** when connecting your TV to a network that supports DHCP. To set up your TV's cable network connection automatically, follow these steps:

How to set up automatically

1. Connect your TV to your LAN as described in the previous section.
2. Turn on your TV, press the **MENU** button on your remote, use the **▲** or **▼** button to select **Setup**, and then press the **ENTER** button.
3. Use the **▲** or **▼** button to select **Network** in the **Setup** menu, and then press the **ENTER** button. The **Network** screen appears.

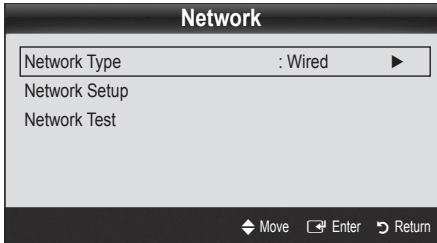

4. On the **Network** screen, select **Network Type**.
5. Set **Network Type** to **Wired**.
6. Select **Network Setup**. The **Network Setup** screen appears.

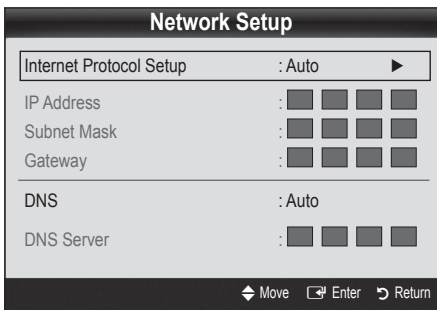

7. Set **Internet Protocol Setup** to **Auto**.
8. **Auto** acquires and enters the needed Internet values automatically.
9. When done, press the **RETURN** button on your remote.
10. If the **Network** Function has not acquired the network connection values, go to the directions for **Manual**.

Network Setup (Manual)

Use the Manual **Network Setup** when connecting your TV to a network that requires a Static IP address.

Getting the Network Connection Values

To get the Network connection values on most Windows computers, follow these steps:

1. Right click the Network icon on the bottom right of the screen.
2. In the pop-up menu that appears, click Status.
3. On the dialog that appears, click the Support tab.
4. On the Support Tab, click the Details button. The Network connection values are displayed.

How to set up manually

To set up your TV's cable network connection manually, follow these steps:

1. Follow Steps 1 through 6 in the "How to set up automatically" procedure.
2. Set **Internet Protocol Setup** to **Manual**.
3. Press the **▼** button on your remote to go to the first entry field.
4. Enter the **IP Address**, **Subnet Mask**, **Gateway**, and **DNS Server** values. Use the number buttons on your remote to enter numbers and the arrow buttons to move from one entry field to another.
5. When done, press the **RETURN** button on your remote.
6. Select **Network Test** to check the Internet connectivity.

Advanced Features

Connecting to a Wireless Network

To connect your TV to your network wirelessly, you need a wireless router or modem and a Samsung Wireless LAN Adapter (WIS09ABGN, WIS09ABGN2, WIS10ABGN), which you connect to your TV's back or side panel USB jack. See the illustration below.

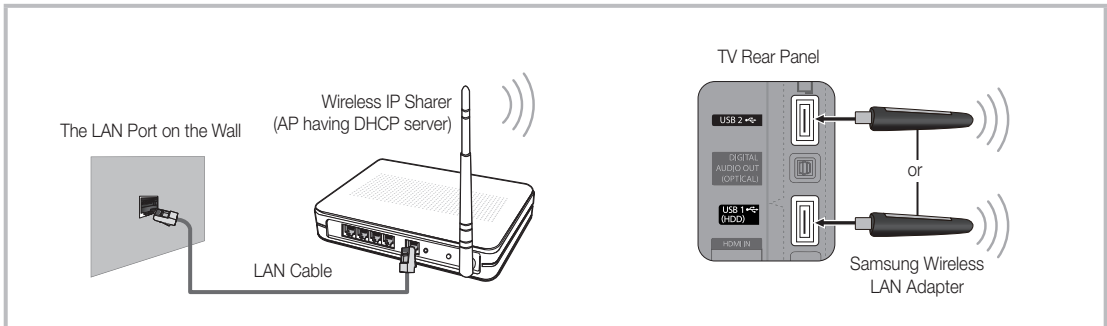

Samsung's Wireless LAN adapter is sold separately and is offered by select retailers, Ecommerce sites and Samsungparts.com. Samsung's Wireless LAN adapter supports the IEEE 802.11A/B/G and N communication protocols. Samsung recommends using IEEE 802.11N. When you play the video over a IEEE 802.11B/G connection, the video may not play smoothly.

NOTE

- You must use the “Samsung Wireless LAN Adapter” (WIS09ABGN, WIS09ABGN2, WIS10ABGN), to use a wireless network.
- Samsung's Wireless LAN adapter is sold separately. The Samsung Wireless LAN adapter is offered by select retailers, Ecommerce sites and Samsungparts.com.
- To use a wireless network, your TV must be connected to a wireless IP sharer. If the wireless IP sharer supports DHCP, your TV can use a DHCP or static IP address to connect to the wireless network.
- Select a channel for the wireless IP sharer that is not currently being used. If the channel set for the wireless IP sharer is currently being used by another device nearby, this will result in interference and communication failure.
- If you apply a security system other than the systems listed below, it will not work with the TV.
- If Pure High-throughput (Greenfield) 802.11N mode is selected and the Encryption type is set to WEP, TKIP or TKIP-AES (WPS2Mixed) for your AP, Samsung TVs will not support a connection in compliance with new Wi-Fi certification specifications.
- If your AP supports WPS (Wi-Fi Protected Setup), you can connect to the network via PBC (Push Button Configuration) or PIN (Personal Identification Number). WPS will automatically configure the SSID and WPA key in either mode.
- If your router, modem, or device isn't certified, it may not connect to the TV via the “Samsung Wireless LAN Adapter.”
- **Connection Methods:** You can setup the wireless network connection four ways.
 - **PBC (WPS)**
 - Auto Setup (Using the Auto Network Search function)
 - Manual Setup
 - **Ad-Hoc**
- The Samsung Wireless LAN Adapter may not be recognized or work properly when connecting via a USB hub or via a USB extension cable other than the one available from Samsung.

Notice

The picture may appear corrupted or have static for some channels when the TV is connected to the Samsung Wireless LAN Adapter. In such a case, establish a connection using one of the following methods or connect the Samsung Wireless LAN Adapter using a USB cable in a place that is not affected by radio interference.

Method 1

Connect using the USB right angle adapter

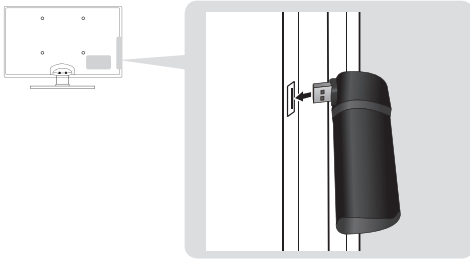
**Method 2**

Connect via an extension cable

 The Samsung Wireless LAN Adapter should be installed in an interference-free area in order to avoid interference between the adapter and tuner.

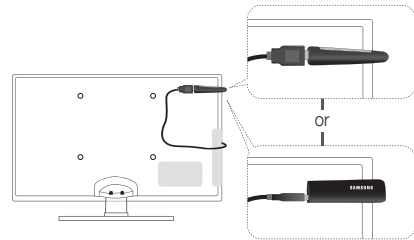
**Network Setup (PBC (WPS))****How to set up using PBC (WPS)**

If your router has a PBC (WPS) button, follow these steps:

1. Connect your TV to your LAN as described in the previous section.
2. Turn on your TV, press the **MENU** button on your remote, use the **▲** or **▼** button to select **Setup**, and then press the **ENTER** button.
3. Use the **▲** or **▼** button to select **Network** in the **Setup** menu, and then press the **ENTER** button.
4. On the **Network** screen, select **Network Type**.
5. Set **Network Type** to **Wireless**.
6. Select **Network Setup**. The **Network Setup** screen appears.

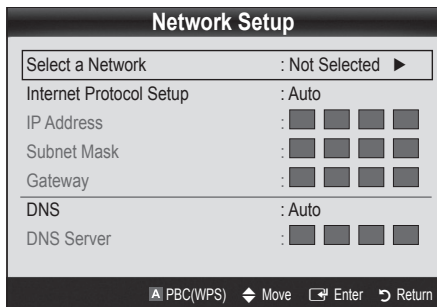

7. Press the Red button on your remote.
8. Press the PBC (WPS) button on your router within 2 minutes. Your TV player automatically acquires all the network setting values it needs and connects to your network.
9. After the network connection is set up, press the **RETURN** button to exit the **Network Setup** screen.

Network Setup (Auto)

Most wireless networks have an optional security system that requires devices that access the network to transmit an encrypted security code called an Access or Security Key. The Security Key is based on a Pass Phrase, typically a word or a series of letters and numbers of a specified length you were asked to enter when you set up security for your wireless network. If you use this method of setting up the network connection, and have a Security Key for your wireless network, you will have to enter the Pass Phrase during the setup process.

Advanced Features

How to set up automatically

To set up the wireless connection automatically, follow these steps:

1. Follow Steps 1 through 6 in the “How to set up using PBC (WPS)” (p. 27).
2. Press the ▼ button to select **Internet Protocol Setup**, and then press the ENTER button. Press the ▲ or ▼ button to select **Auto**, and then press the ENTER button.
3. Press the ▲ button to go to **Select a Network**, and then press the ENTER button. The **Network** function searches for available wireless networks. When done, it displays a list of the available networks.
4. In the list of networks, press the ▲ or ▼ button to select a network, and then press the ENTER button.
 If the AP is set to Hidden (Invisible), you have to select **Add Network** and enter the correct **Network Name (SSID)** and **Security Key** to establish the connection.
5. If the Security/PIN pop-up appears, go to Step 6. If the Network Connecting Screen appears, go to Step 10.
6. Press the ▲ or ▼ button to select **Security or PIN**. For most home networks, you would select Security (for **Security Key**). The **Security** Screen appears.

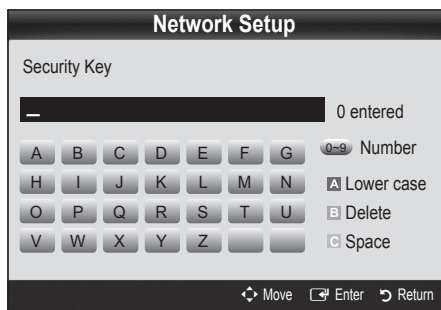

7. On the **Security** screen, enter your network's Pass Phrase.
 You should be able to find the Pass Phrase on one of the set up screens you used to set up your router or modem.

8. To enter the Pass Phrase, follow these general directions:
 - Press the number buttons on your remote to enter numbers.
 - Use the direction buttons on your remote to move from button to button on the **Security Key** screen.
 - Press the Red button to change case or display symbols/characters.
 - To enter letter or symbol, move to the letter or symbol, and then press the ENTER button.
 - To delete the last letter or number you entered, press the Green button on your remote.
9. When done, press the Blue button on your remote. The Network Connecting screen appears.
10. Wait until the connection confirmation message is displayed, and then press the ENTER button. The **Network Setup** screen re-appears.
11. To test the connection, press the RETURN button to select **Network Test**, and then press the ENTER button.

Network Setup (Ad-Hoc)

You can connect to a mobile device without an access point through the “Samsung Wireless LAN Adapter” by using a peer to peer network.

How to connect to new Ad-hoc device

1. Follow Steps 1 through 6 in the “How to set up using PBC (WPS)” (p. 27).
2. Choose **Select a Network**. A list of devices/networks appears.
3. While in the device list, press the Blue button on the remote.
 The message **Ad-hoc is a direct Wi-Fi connection with cell phone or PC. The existing network system may have limited functionality. Do you want to change the network connection?** is displayed.
4. Input the generated **Network Name (SSID)** and **Security Key** into the device you want to connect.

How to connect an existing Ad-hoc device

1. Follow Steps 1 through 6 in the “How to set up using PBC (WPS)” (p. 27).
2. Choose **Select a Network**. The Device/Network list appears.
3. Select the device you want in the Device list.
4. If security key is required, input the security key.
 If network doesn't operate normally, check the **Network Name (SSID)** and **Security Key** again. An incorrect **Security Key** may cause a malfunction.

Network Setup (Manual)

If the other methods do not work, you need to enter the Network setting values manually.



Getting the Network Connection Values

To get the Network connection values on most Windows computers, follow these steps:

1. Right click the Network icon on the bottom right of the screen.
2. In the pop-up menu, click Status.
3. On the dialog that appears, click the Support tab.
4. On the Support tab, click the Details button. The Network settings are displayed.

How to set up manually

To enter the Network connection values manually, follow these steps:

1. Follow Steps 1 through 6 in the "How to set up using PBC (WPS)" (p. 27).
2. Press the ▼ button to select **Internet Protocol Setup**, and then press the ENTER  button. Press the ▲ or ▼ button to select **Manual**, and then press the ENTER  button.
3. Press the ▼ button to go to the first entry field (IP Address).
4. Use the number buttons to enter numbers.
5. When done with each field, use the ► button to move successively to the next field. You can also use the other arrow buttons to move up, down, and back.
6. Enter the **IP Address**, **Subnet Mask**, and **Gateway** values.
7. Press the ▲ or ▼ button to go to **DNS**.
8. Press the ▼ button to go to the first DNS entry field. Enter the numbers as above.
9. When done, press the ▲ button to go to **Select a Network**. Select your network, and then press the ENTER  button.
10. Go to Step 4 in the "How to set up automatically" (p. 28), and follow the directions from that point on.

If Your TV Fails to Connect to the Internet

Your TV may not be able to connect to the Internet because your ISP has permanently registered the MAC address (a unique identifying number) of your PC or modem, which it then authenticates each time you connect to the Internet as a way of preventing unauthorized access. As your TV has a different MAC address, your ISP can not authenticate its MAC address, and your TV can not connect.

To resolve this problem, ask your ISP about the procedures required to connect devices other than a PC (such as your TV) to the Internet.

If your Internet service provider requires an ID or password to connect to the Internet, your TV may not be able to connect to the Internet. If this is the case, you must enter your ID or password when connecting to the Internet.

The internet connection may fail because of a firewall problem. If this is the case, contact your Internet service provider.

If you cannot connect to the Internet even after you have followed the procedures of your Internet service provider, please contact Samsung Electronics at 1-800-SAMSUNG.

Advanced Features

Media Play



Enjoy photos, music and/or movie files saved on a USB Mass Storage Class (MSC) device and/or your PC.



Connecting a USB Device

1. Turn on your TV.
2. Connect a USB device containing photo, music and/or movie files to the **USB 1 (HDD)** or **USB 2** jack on the side of the TV.
3. When USB is connected to the TV, popup window appears. Then you can select **Media Play**.

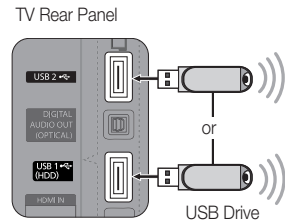

Connecting to the PC through network

You can play pictures, music and videos saved on your PC through a network connection in the **Media Play** mode.

If you use **Media Play** through saved file on your PC, you should download "PC Share Manager" and users manual from "www.samsung.com."

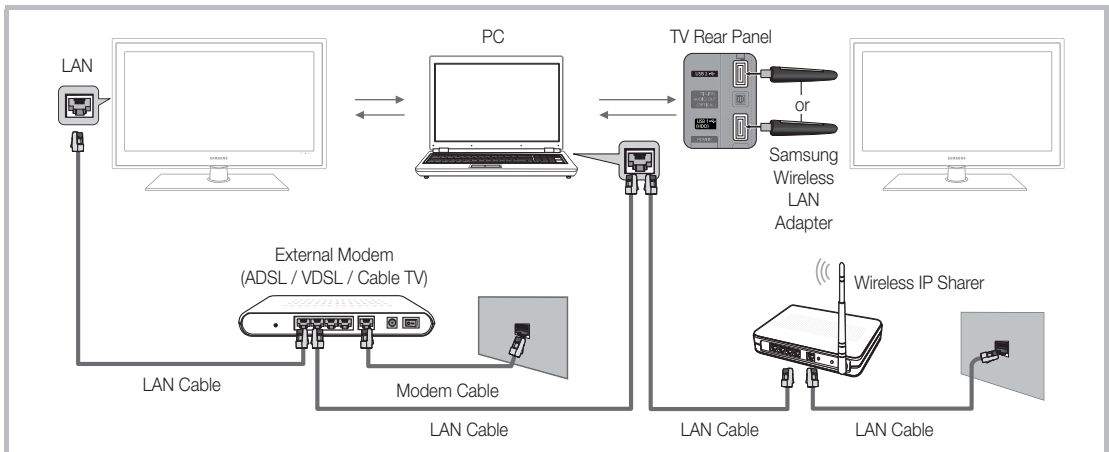

1. For more information on how to configure your network, refer to "Network Connection." (p. 24).
 - You are recommended to locate both TV and PC in same subnet. The first 3 parts of the subnet address of the TV and the PC IP addresses should be the same and only the last part (the host address) should be changed. (e.g. IP Address: 123.456.789.**)
2. Using a LAN cable, connect between the external modem and the PC onto which the Samsung PC Share Manager programme will be installed.
 - You can connect the TV to the PC directly without connecting it through a Sharer (Router).

- ✎ No supported functions when connecting to the PC through network:
 - The **Background Music** and **Background Music Setting** functions.
 - Sorting files by preference in the **Photos**, **Music**, and **Videos** folders.
 - The ◀ (REW) or ▶ (FF) button while a movie is playing.
- ✎ The Divx DRM, Multi-audio, embedded caption does not supported.
- ✎ Samsung PC Share manager should be permitted by the firewall programme on your PC.
- ✎ When you use **Media Play** mode through a network connection, according to functions of the provided server:
 - The sorting method may vary.
 - The scene search function may not be supported.
 - The **Play Continuously** function, which resumes playing of a video, may not be supported.
 - The **Play Continuously** function does not support multiple users. (It will have only memorised the point where the most recent user stopped playing.)
 - The ◀ or ▶ button may not work depending on the content information.
 - You may experience file stuttering while playing a video in Media Play through a network connection.
- ✎ It might not work properly with unlicensed multimedia files.
- ✎ Need-to-Know List before using **Media Play**
 - MTP (Media Transfer Protocol) is not supported.
 - The file system supports FAT16, FAT32 and NTFS.
 - Certain types of USB Digital camera and audio devices may not be compatible with this TV.
 - Media Play only supports USB Mass Storage Class (MSC) devices. MSC is a Mass Storage Class Bulk-Only Transport device. Examples of MSC are Thumb drives, Flash Card Readers and USB HDD (USB HUB are not supported). Devices should be connected directly to the TV's USB port.
 - Before connecting your device to the TV, please back up your files to prevent them from damage or loss of data. SAMSUNG is not responsible for any data file damage or data loss.
 - Connect a USB HDD to the dedicated port, **USB 1 (HDD)** port.
 - Do not disconnect the USB device while it is loading.
 - The higher the resolution of the image, the longer it takes to display on the screen.
 - The maximum supported JPEG resolution is 15360X8640 pixels.
 - For unsupported or corrupted files, the "Not Supported File Format" message is displayed.
 - If the files are sorted by Basic View, up to 1000 files can be displayed in each folder.
 - MP3 files with DRM that have been downloaded from a non-free site cannot be played. Digital Rights Management (DRM) is a technology that supports the creation of content, the distribution and management of the content in an integrated and comprehensive way, including the protection of the rights and interests of the content providers, the prevention of the illegal copying of contents, as well as managing billings and settlements.
 - If more than 2 PTP devices are connected, you can only use one at a time.
 - If more than two MSC devices are connected, some of them may not be recognized. A USB device that requires high power (more than 500mA or 5V) may not be supported.
 - If an over-power warning message is displayed while you are connecting or using a USB device, the device may not be recognized or may malfunction.
 - If the TV has been no input during time set in **Auto Protection Time**, the Screensaver will run.
 - The power-saving mode of some external hard disk drives may be released automatically when connected to the TV.
 - If a USB extension cable is used, the USB device may not be recognized or the files on the device may not be read.
 - If a USB device connected to the TV is not recognized, the list of files on the device is corrupted or a file in the list is not played, connect the USB device to the PC, format the device and check the connection.
 - If a file deleted from the PC is still found when Media Play is run, use the "Empty the Recycle Bin" function on the PC to permanently delete the file.

Advanced Features

Screen Display

Move to the file you desired using the up/down/right/left buttons and then press the **ENTER** or **(Play)** button. The file is played.

Supports the **View Devices** and **Home** in **Media Play** homepage.

Information:
You can ascertain the selected file name and the number of files and page.

Sort List Section:
Displays sorting standard.

Sorting standard is different depending on the contents.

File List Section:
You can confirm the files and groups that is sorted by each category.

Operation Buttons

- Red (Change Device):** Selects a connected device.
- Green (Preference):** Sets the file preference. (not supported in Basic view)
- Yellow (Select):** Selects multiple files from file list. Selected files are marked with a symbol.
- Blue (Sorting):** Selects the sort list.
- Tools:** Displays the option menu.

Using the **(REW)** or **(FF)** button, file list can move to next or previous page.

Videos

Playing Video

1. Press the **◀** or **▶** button to select **Videos**, then press the **ENTER** button in the **Media Play** menu.
2. Press the **◀/▶/▲/▼** button to select the desired file in the file list.
3. Press the **ENTER** button or **(Play)** button.
 - The selected file is displayed on the top with its playing time.
 - If video time information is unknown, play time and progress bar are not displayed.
 - During playing the video, you can search using the **◀** and **▶** button.

In this mode, you can enjoy movie clips contained on a Game, but you cannot play the Game itself.

- Supported Subtitle Formats

Name	File extension	Format
MPEG-4 time-based text	.txt	XML
SAMI	.smi	HTML
SubRip	.srt	string-based
SubViewer	.sub	string-based
Micro DVD	.sub or .txt	string-based

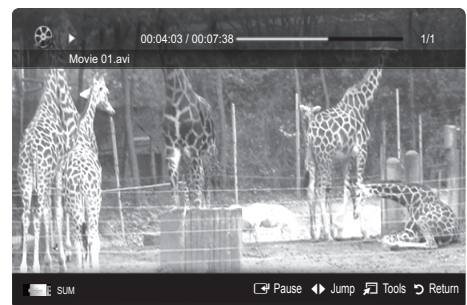

- Supported Video Formats

File Extension	Container	Video Codec	Resolution	Frame rate (fps)	Bit rate (Mbps)	Audio Codec
*.avi *.mkv	AVI MKV	Divx 3.11 / 4.x / 5.1 / 6.0	1920x1080	6 ~ 30	8	MP3 / AC3 / LPCM / ADPCM / DTS Core
		XviD	1920x1080	6 ~ 30	8	
		H.264 BP / MP / HP	1920x1080	6 ~ 30	25	
		MPEG4 SP / ASP	1920x1080	6 ~ 30	8	
*.asf	ASF	Divx 3.11 / 4.x / 5.1 / 6.0	1920x1080	6 ~ 30	8	MP3 / AC3 / LPCM / ADPCM / WMA
		XviD	1920x1080	6 ~ 30	8	
		H.264 BP / MP / HP	1920x1080	6 ~ 30	25	
		MPEG4 SP / ASP	1920x1080	6 ~ 30	8	
*.wmv	ASF	Window Media Video v9	1920x1080	6 ~ 30	25	WMA
*.mp4	MP4	H.264 BP / MP / HP	1920x1080	6 ~ 30	25	MP3 / ADPCM / AAC
		MPEG4 SP / ASP	1920x1080	6 ~ 30	8	
		XVID	1920x1080	6 ~ 30	8	
*.3gp	3GPP	H.264 BP / MP / HP	1920x1080	6 ~ 30	25	ADPCM / AAC / HE-AAC
		MPEG4 SP / ASP	1920x1080	6 ~ 30	8	
*.vro *.vob	VRO VOB	MPEG1	1920x1080	24 / 25 / 30	30	AC3 / MPEG / LPCM
		MPEG2	1920x1080	24 / 25 / 30	30	
*.mpg *.mpeg	PS	MPEG1	1920x1080	24 / 25 / 30	30	AC3 / MPEG / LPCM / AAC
		MPEG2	1920x1080	24 / 25 / 30	30	
		H.264	1920x1080	6 ~ 30	25	
*.ts *.tp *.trp	TS	MPEG2	1920x1080	24 / 25 / 30	30	AC3 / AAC / MP3 / DD+ / HE-AAC
		H.264	1920x1080	6 ~ 30	25	
		VC1	1920x1080	6 ~ 30	25	

Other Restrictions



NOTE

- If there are problems with the contents of a codec, the codec will not be supported.
- If the information for a Container is incorrect and the file is in error, the Container will not be able to play correctly.
- Sound or video may not work if the contents have a standard bitrate/frame rate above the compatible Frame/sec listed in the table above.
- If the Index Table is in error, the Seek (Jump) function is not supported.

Video Decoder	Audio Decoder
<ul style="list-style-type: none"> Supports up to H.264, Level 4.1 H.264 FMO / ASO / RS, VC1 SP / MP / AP L4 and AVCHD are not supported. GMC is not supported. H.263 is not supported. 	<ul style="list-style-type: none"> Supports up to WMA 7, 8, 9, STD WMA 9 PRO does not support 2 channel excess multi channel or lossless audio. WMA sampling rate 22050Hz mono is not supported.

Advanced Features

Playing movie file continuously (Resume Play)

If you exit the playing Videos function, it can be played later from the point where it was stopped.

1. Select the movie file you want to play continuously by pressing the ◀ or ▶ button to select it from the file list section.
2. Press the ▶ (Play) / ENTER button.
3. Select **Play Continuously** (Resume Play) by pressing the Blue button. The Movie will begin to play from where it was stopped.
 - ✎ The Blue button is available when resuming play.
 - ✎ If the **Cont. movie play help** function is set to **On** in the **Settings** menu, a pop-up message will appear when you resume play a movie file.

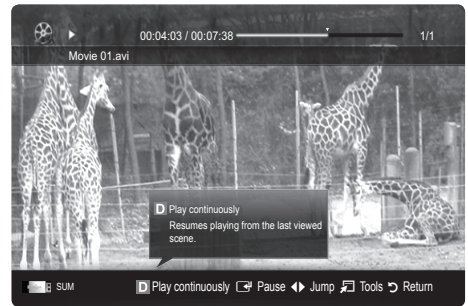

Music

Playing Music

1. Press the ◀ or ▶ button to select **Music**, then press the ENTER button in the **Media Play** menu.
 2. Press the ◀/▶/▲/▼ button to select the desired file in the file list.
 3. Press the ENTER button or ▶ (Play) button.
 - During playing the music, you can search using the ◀ and ▶ button.
 - ◀◀ (REW) and ▶▶ (FF) buttons do not function during play.
- ✎ Only displays the files with MP3 and PCM file extension. Other file extensions are not displayed, even if they are saved on the same USB device.
- ✎ If the sound is strange when playing MP3 files, adjust the **Equalizer** in the **Sound** menu. (An over-modulated MP3 file may cause a sound problem.)

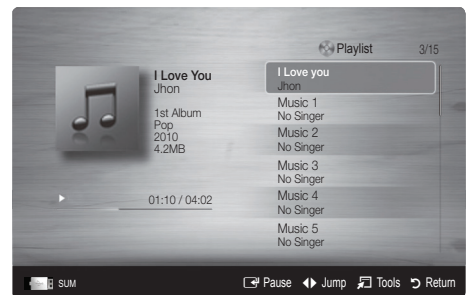

Photos

Viewing a Photo (or Slide Show)

1. Press the ◀ or ▶ button to select **Photos**, then press the ENTER button in the **Media Play** menu.
 2. Press the ◀/▶/▲/▼ button to select the desired file in the file list.
 3. Press the ENTER button or ▶ (Play) button.
 - While a photo list is displayed, press the ▶ (Play) / ENTER button on the remote control to start slide show.
 - All files in the file list section will be displayed in the slide show.
 - During the slide show, files are displayed in order from currently being shown.
- ✎ Music files can be automatically played during the Slide Show if the **Background Music** is set to **On**.
- ✎ The **BGM Mode** cannot be changed until the BGM has finished loading.



Playing the Multiple Files

Playing the selected video/music/photo files

1. Press the Yellow button in the file list to select the desired file.
2. Repeat the above operation to select multiple files.

NOTE

- The ✓ mark appears to the left of the selected files.
- To cancel a selection, press the Yellow button again.
- To deselect all selected files, press the TOOLS button and select **Deselect All**.

3. Press the TOOLS button and select **Play Selected Contents**.

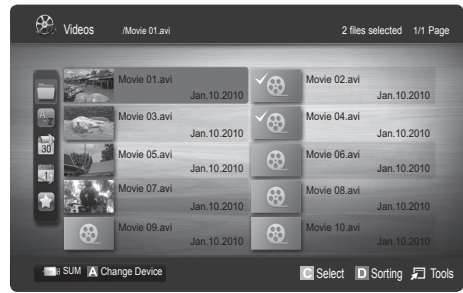











Playing the video/music/photo file group

1. While a file list is displayed, move to the any file in desired group.
2. Press the TOOLS button and select **Play Current Group**.

Media Play Additional Function

Sorting the file list

Press the Blue button in the file list to sort the files.

Category	Operations	Videos	Music	Photos
 Basic View	It shows whole folder. You can view the photo by selecting the folder.	▼	▼	▼
 Title	It sorts and displays the file title in Symbol/Number/Alphabet/Special order.	▼	▼	▼
 Preference	It sorts and displays the file by preference. You can change the file preference in the file list section using the Green button.	▼	▼	▼
 Latest Date	It sorts and shows files by latest date.	▼		▼
 Earliest Date	It sorts and shows files by earliest date.	▼		▼
 Artist	It sorts the music file by artist in alphabetical.		▼	
 Album	It sorts the music file by album in alphabetical order.		▼	
 Genre	It sorts music files by the genre.		▼	
 Mood	It sorts music files by the mood. You can change the music mood information.		▼	
 Monthly	It sorts and shows photo files by month. It sorts only by month (from January to December) regardless of year.			▼

Advanced Features

Videos/Music/Photos Play Option menu

During playing a file, press the TOOLS button.

Category	Operations	Videos	Music	Photos
Title	You can move the other file directly.	▼		
Repeat Mode	You can play movie and music files repeatedly.	▼	▼	
Picture Size	You can adjust the picture size for preference.	▼		
Picture Setting	You can adjust the picture setting. (p. 15, 16, 17)	▼		▼
Sound Setting	You can adjust the sound setting. (p. 17, 18, 19)	▼	▼	▼
Subtitle Setting	You can play the video file with Subtitle. This function only works if the subtitles are the same file name as the video file.	▼		
Stop Slide Show / Start Slide Show	You can start or stop a slide show.			▼
Slide Show Speed	You can select the slide show speed during the slide show.			▼
Background Music	You can set and select background music when watching a slide show.			▼
Zoom	You can zoom into images in full screen mode.			▼
Rotate	You can rotate images in full screen mode.			▼
Information	You can see detailed information about the played file.	▼	▼	▼

Settings

Using the Setup Menu

- **Cont. movie play help (Resume Play) (On / Off):** Select to display the help pop-up message for continuous movie playback.
- **Get the DivX® VOD registration code:** Shows the registration code authorized for the TV. If you connect to the DivX web site and register the registration code with a personal account, you can download VOD registration file. If you play the VOD registration using Media Play, the registration is completed.
 For more information on DivX® VOD, visit "www.DivX.com."
- **Get the DivX® VOD deactivation code:** When DivX® VOD is not registered, the registration deactivation code is displayed. If you execute this function when DivX® VOD is registered, the current DivX® VOD registration is deactivated.
- **Information:** Select to view information about the connected device.

What is Anynet+? 

Anynet+ is a function that enables you to control all connected Samsung devices that support Anynet+ with your Samsung TV's remote. The Anynet+ system can be used only with Samsung devices that have the Anynet+ feature. To be sure your Samsung device has this feature, check if there is an Anynet+ logo on it.

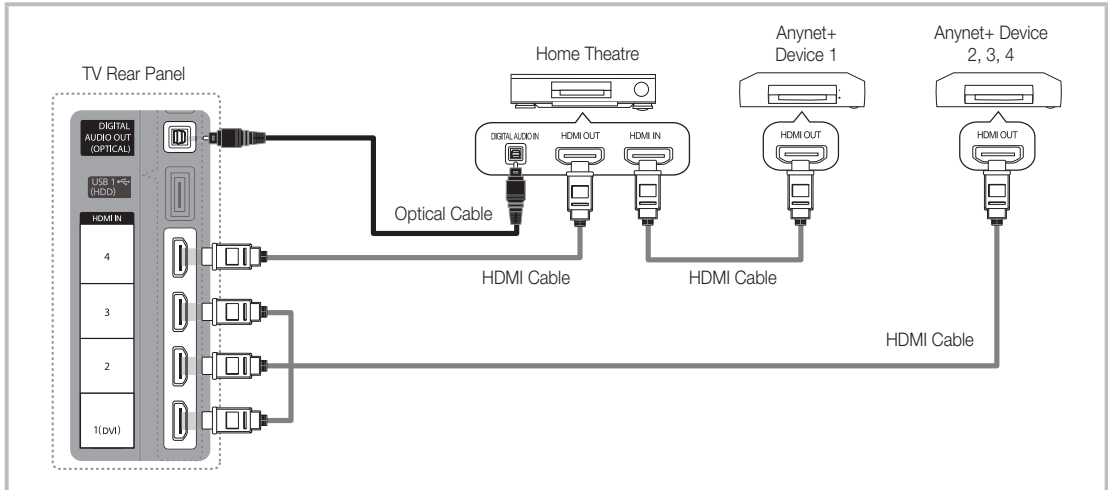
To connect to Home Theatre

1. Connect the HDMI IN (1 (DVI), 2, 3 or 4) jack on the TV and the HDMI OUT jack of the corresponding Anynet+ device using an HDMI cable.
2. Connect the HDMI IN jack of the home theatre and the HDMI OUT jack of the corresponding Anynet+ device using an HDMI cable.

 **NOTE**

- Connect the Optical cable between the **DIGITAL AUDIO OUT (OPTICAL)** jack on your TV and the Digital Audio Input on the Home Theatre.
- When following the connection above, the Optical jack only outputs 2 channel audio. You will only hear sound from the Home Theatre's Front, Left and Right speakers and the subwoofer. If you want to hear 5.1 channel audio, connect the **DIGITAL AUDIO OUT (OPTICAL)** jack on the DVD / Satellite Box (i.e. Anynet Device 1 or 2) directly to the Amplifier or Home Theatre, not the TV.
- Connect only one Home Theatre.
- You can connect an Anynet+ device using the HDMI cable. Some HDMI cables may not support Anynet+ functions.
- Anynet+ works when the AV device supporting Anynet+ is in the standby or on status.
- Anynet+ supports up to 12 AV devices in total. Note that you can connect up to 3 devices of the same type.

Advanced Features

Anynet+ Menu

The Anynet+ menu changes depending on the type and status of the Anynet+ devices connected to the TV.

Anynet+ Menu	Description
View TV	Changes Anynet+ mode to TV broadcast mode.
Device List	Shows the Anynet+ device list.
(device_name) MENU	Shows the connected device menus. E.g. If a DVD recorder is connected, the disc menu of the DVD recorder will appear.
(device_name) INFO	Shows the play menu of the connected device. E.g. If a DVD recorder is connected, the play menu of the DVD recorder will appear.
Recording: (*recorder)	Starts recording immediately using the recorder. (This is only available for devices that support the recording function.)
Stop Recording: (*recorder)	Stops recording.
Receiver	Sound is played through the receiver.

If more than one recording device is connected, they are displayed as (*recorder) and if only one recording device is connected, it will be represented as (*device_name).

Setting Up Anynet+

Setup

Anynet+ (HDMI-CEC) (Off / On): To use the Anynet+ Function, **Anynet+ (HDMI-CEC)** must be set to **On**.



 When the **Anynet+ (HDMI-CEC)** function is disabled, all the Anynet+ related operations are deactivated.

Auto Turn Off (No / Yes): Setting an Anynet+ Device to turn off automatically when the TV is turned off.

 The active source on the TV must be set to TV to use the Anynet+ function.







 Even if an external device is still recording, it may turn off.

Switching between Anynet+ Devices

1. Anynet+ devices connected to the TV are listed.
 -  If you cannot find a device you want, press the Red button to refresh the list.
2. Select a device and press the **ENTER**  button. You can switch to the selected device.
 -  Only when you set **Anynet+ (HDMI-CEC)** to **On** in the **Application** menu, the **Device List** menu appears.
 - Switching to the selected device may take up to 2 minutes. You cannot cancel the operation during the switching operation.
 - If you have selected external input mode by pressing the **SOURCE** button, you cannot use the Anynet+ function. Make sure to switch to an Anynet+ device by using the **Device List**.

Recording



You can make a recording of a TV Programme using a Samsung recorder.

1. Select **Recording**.
 -  When there are more than two recording devices
 - When multiple recording devices are connected, the recording devices are listed. Select one recording device in the **Device List**.
 -  When the recording device is not displayed, select **Device List** and press the Red button to search devices.
2. Press the **EXIT** button to exit.
 -  You can record the source streams by selecting **Recording:** (device_name).
 -  Pressing the  (REC) button will record whatever you are currently watching. If you are watching video from another device, the video from the device is recorded.
 -  Before recording, check whether the antenna jack is properly connected to the recording device. To properly connect an antenna to a recording device, refer to the recording device's users manual.

Listening through a Receiver

You can listen to sound through a receiver (i.e Home Theatre) instead of the **TV Speaker**.



1. Select **Receiver** and set to **On**.
2. Press the **EXIT** button to exit.

-  If your receiver supports audio only, it may not appear in the device list.
-  The receiver will work when you have properly connected the optical in jack of the receiver to the **DIGITAL AUDIO OUT (OPTICAL)** jack of the TV.
-  When the receiver (i.e Home Theatre) is set to On, you can hear sound output from the TV's Optical jack. When the TV is displaying a DTV (aerial) signal, the TV will send out 5.1 channel sound to the receiver. When the source is a digital component such as a DVD and is connected to the TV via HDMI, only 2 channel sound will be heard from the receiver.

NOTE

- You can only control Anynet+ devices using the TV remote control, not the buttons on the TV.
- The TV remote control may not work under certain conditions. If this occurs, reselect the Anynet+ device.
- The Anynet+ functions do not operate with other manufacturers' products.

Troubleshooting for Anynet+

Problem	Possible Solution
Anynet+ does not work.	<ul style="list-style-type: none"> • Check if the device is an Anynet+ device. The Anynet+ system supports Anynet+ devices only. • Connect only one receiver (home theatre). • Check if the Anynet+ device power cord is properly connected. • Check the Anynet+ device's Video/Audio/HDMI cable connections. • Check whether Anynet+ (HDMI-CEC) is set to On in the Anynet+ setup menu. • Check whether the TV remote control is in TV mode. • Check whether it is Anynet+ exclusive remote control. • Anynet+ doesn't work in certain situations. (Searching channels, operating Media Play or Plug & Play (Initial setup), etc.) • When connecting or removing the HDMI cable, please make sure to search devices again or turn your TV off and on again. • Check if the Anynet+ Function of Anynet+ device is set on.
I want to start Anynet+.	<ul style="list-style-type: none"> • Check if the Anynet+ device is properly connected to the TV and check if the Anynet+ (HDMI-CEC) is set to On in the Anynet+ Setup menu. • Press the TOOLS button to display the Anynet+ menu and select a menu you want.
I want to exit Anynet+.	<ul style="list-style-type: none"> • Select View TV in the Anynet+ menu. • Press the SOURCE button on the TV remote control and select a device other than Anynet+ devices. • Press P , , and PRE-CH to change the TV mode. (Note that the channel button operates only when a tuner-embedded Anynet+ device is not connected.)
The message "Connecting to Anynet+ device..." appears on the screen.	<ul style="list-style-type: none"> • You cannot use the remote control when you are configuring Anynet+ or switching to a view mode. • Use the remote control when the Anynet+ setting or switching to view mode is complete.
The Anynet+ device does not play.	<ul style="list-style-type: none"> • You cannot use the play function when Plug & Play (Initial setup) is in progress.
The connected device is not displayed.	<ul style="list-style-type: none"> • Check whether or not the device supports Anynet+ functions. • Check whether or not the HDMI cable is properly connected. • Check whether Anynet+ (HDMI-CEC) is set to On in the Anynet+ setup menu. • Search Anynet+ devices again. • You can connect an Anynet+ device using the HDMI cable only. Some HDMI cables may not support Anynet+ functions. • If it is terminated by an abnormal situation such as disconnecting the HDMI cable or power cord or a power failure, please repeat the device scan.
The TV Programme cannot be recorded.	<ul style="list-style-type: none"> • Check whether the antenna jack on the recording device is properly connected.
The TV sound is not output through the receiver.	<ul style="list-style-type: none"> • Connect the optical cable between TV and the receiver.

Advanced Features

AllShare

About AllShare

AllShare connects your TV, mobile phones and other devices which are compatible through a network. On your TV, you can view call arrivals, SMS messages and schedules set on your mobile phones. In addition, you can play media contents including videos, photos and music saved on your mobile phones or the other devices (such as your PC) by controlling them on the TV via the network. Additionally, you can use your TV as a monitor for your mobile when browsing a web page.

For more information, visit “www.samsung.com” or contact the Samsung call centre. Mobile devices may need additional software installation. For details, refer to each device's user's guide.

Setting Up AllShare

Setup

- **Message (On / Off):** Enables or disables the message function (for call arrivals, SMS messages and schedules set on your mobile phones).
- **Media (On / Off):** Enables or disables the media function. When the media function is on, it plays videos, photos and music from a mobile phone or other device that supports **AllShare**.
- **ScreenShare (On / Off):** Enables or disables the ScreenShare function for using mobile phone as a remote control.
- **TV name:** Sets the TV name so you can find it easily on a mobile device.

If you select **User Input**, you can type on the TV using the OSK (On Screen Keyboard).



Message / Media / ScreenShare

Shows a list of mobile phones or connected devices which have been set up with this TV for using the **Message**, **Media**, or **ScreenShare** function.

The **Media** function is available in all mobile devices which support **AllShare**.

■ **Allowed / Denied:** Allows/Blocks the mobile phone.

■ **Delete:** Deletes the mobile phone from the list.

This function only deletes the name of the mobile from the list. If the deleted mobile device is turned on or tries to connect to the TV, it may appear on the list again.

Using the Message Function

Using this function, you view call arrivals, SMS messages and schedules set on the mobile phone through the alarm window while watching TV.

NOTE

- To disable the alarm window, set **Message** to **Off** in **Setup** of **AllShare**.
- If **OK** is selected, or if **OK** is not selected after the message has appeared three times, the message will be deleted. The message is not deleted from the mobile phone.
- The alarm window can be displayed while using some applications such as **Media Play** etc. To view the contents of a message, switch to TV viewing mode.
- When a message from an unknown mobile phone is displayed, select the mobile phone on the message menu in **AllShare** and select **Denied** to block the phone.

Message View

If a new SMS message arrives while you are watching TV, the alarm window appears. If you click the OK button, the contents of the message are displayed.

You can configure the viewing settings for SMS messages on your mobile phones. For the procedures, refer to the mobile phone manual.



Some types of characters may be displayed as blank or broken characters.

Call Arrival Alarm

If a call arrives while you are watching TV, the alarm window appears.

Schedule Alarm

While you are watching TV, the alarm window appears to display the registered event.

-  You can configure viewing settings for schedule contents on your mobile phones. For the procedures, refer to the mobile phone manual.
-  Some special characters may be displayed as blank or broken characters.

Using the Media Function

An alarm window appears informing the user that the media contents (videos, photos, music) sent from a mobile phone will be displayed on your TV. The contents are played automatically 3 seconds after the alarm window appears. If you press the **RETURN** or **EXIT** button when the alarm window appears, the media contents are not played.

NOTE

- If the media function executes for the first time, the warning popup window appears. Press the **ENTER**  button to select **Allow**, then you can use Media function on that device.

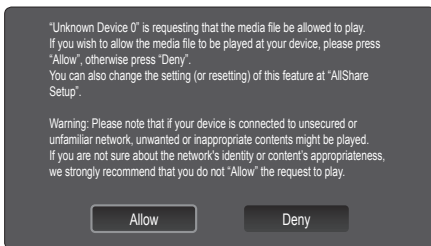

- To turn off the media contents transmission from the mobile phone, set **Media** to **Off** in the **AllShare** setup.
- Contents may not be played on your TV depending on their resolution and format.
- The **ENTER**  and **◀ / ▶** buttons may not work depending on the type of media content.
- Using the mobile device, you can control the media playing. For details, refer to each mobile's user's guide.
- When you want to play media contents from your PC, select the PC icon on the main display of **AllShare**. Then the TV's **Media Play** menu automatically changes. For more detail information, refer to "Media Play" (p. 30).

Using ScreenShare Function

ScreenShare displays the same web page as provide in mobile. Using ScreenShare, you can open the various contents saved in a mobile phone. For example, the image below displays an access page for contents from a mobile. You can read the mobile's various files and view the phone book and calendar on the TV. Also, in phone book, you can make a call to other person, or can send to SMS.

NOTE

- In Samsung mobile, ScreenShare must be installed and the supporting application must be executed; then you can use the ScreenShare function.
- Available buttons on your remote control may vary for each page.
- **Doc Viewer** can read files in doc format, but cannot modify them.
- The screen display may differ depending on the connected device.

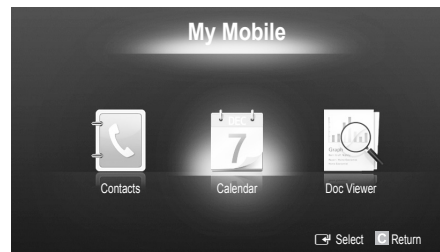

Using your Samsung phone to control your TV Simply

Before you can use this feature, you must connect to a Samsung mobile phone that supports ScreenShare functions. When operating the TV with your mobile phone, only the **POWER**, **-** , **+** , **P**  and **MUTE** buttons are supported.







-  Even if you keep pressing down on a control button (channel or volume) on the mobile phone, the value will only go up or down by one unit.

Other Information





Analogue Channel Teletext Feature

The index page of the Teletext service gives you information on how to use the service. For Teletext information to be displayed correctly, channel reception must be stable. Otherwise, information may be missing or some pages may not be displayed.

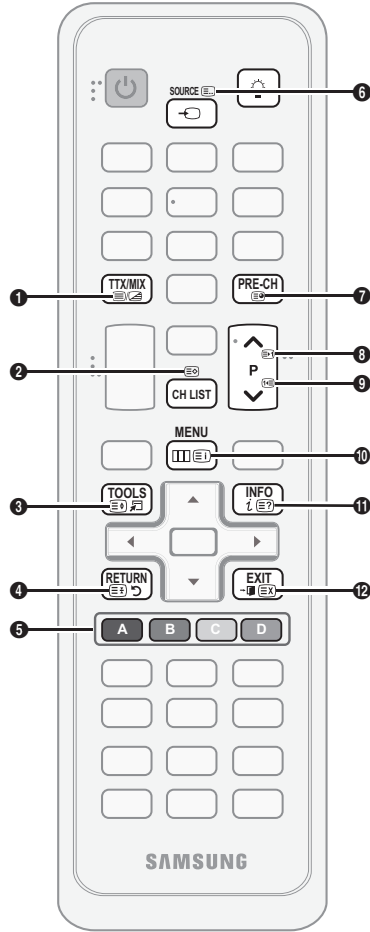
 You can change Teletext pages by pressing the numeric buttons on the remote control.

- 1  (Teletext on/mix/off): Activates the Teletext mode for the current channel. Press the button twice to overlap the Teletext mode with the current broadcasting screen. Press it one more time to exit teletext.
- 2  (store): Stores the Teletext pages.
- 3  (size): Displays the teletext on the upper half of the screen in double-size. To move the text to the lower half of the screen, press it again. For normal display, press it once again.
- 4  (hold): Holds the display at the current page, in the case that there are several secondary pages that follow automatically. To undo, press it again.
- 5 Colour buttons (red, green, yellow, blue): If the FASTEXT system is used by the broadcasting company, the different topics on a Teletext page are colour-coded and can be selected by pressing the coloured buttons. Press the colour corresponding to the topic of your choice. A new colour-coded page is displayed. Items can be selected in the same way. To display the previous or next page, press the corresponding coloured button.
- 6  (mode): Selects the Teletext mode (LIST/ FLOF).
If pressed during LIST mode, switches the mode to List save mode. In List save mode, you can save a Teletext page into a list using the  (store) button.
- 7  (sub-page): Displays the available sub-page.



- 8  (page up): Displays the next Teletext page.
- 9  (page down): Displays the previous Teletext page.
- 10  (index): Displays the index (contents) page at any time while you are viewing Teletext.
- 11  (reveal): Displays the hidden text (answers to quiz games, for example). To display the normal screen, press it again.
- 12  (cancel): Shrinks the Teletext display to overlap with the current broadcast.

Typical Teletext page

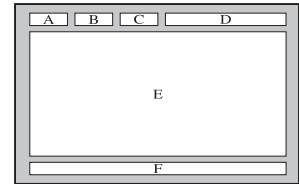

Part	Contents
A	Selected page number.
B	Broadcasting channel identity.
C	Current page number or search indications.
D	Date and time.
E	Text.
F	Status information. FASTEXT information.

Stand Type

Enclose the cables in the Cable Tie so that the cables are not visible through the transparent stand.

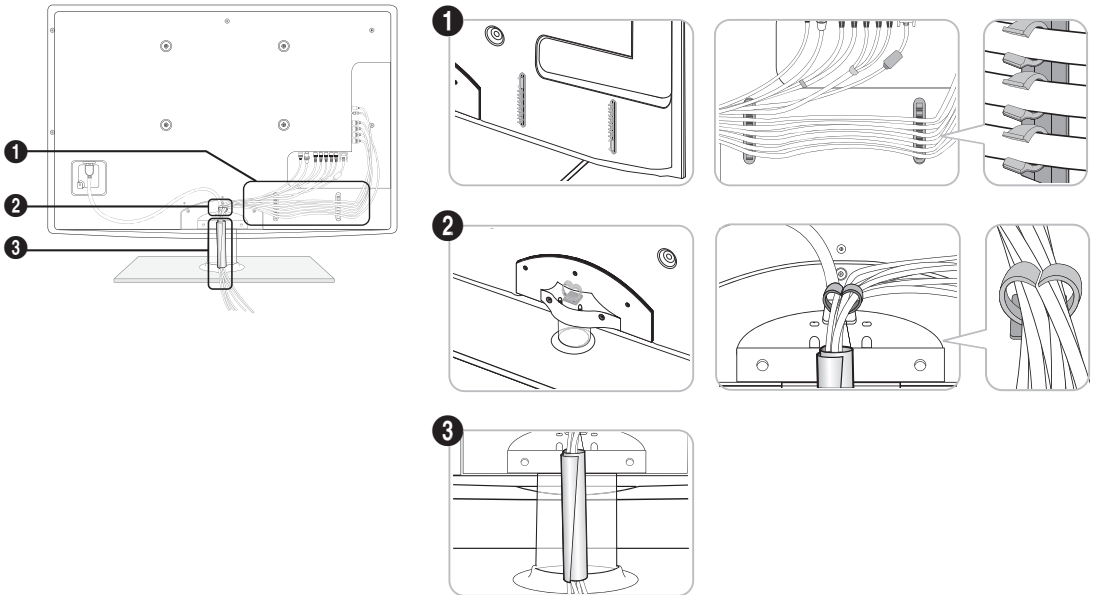

Wall-Mount Type

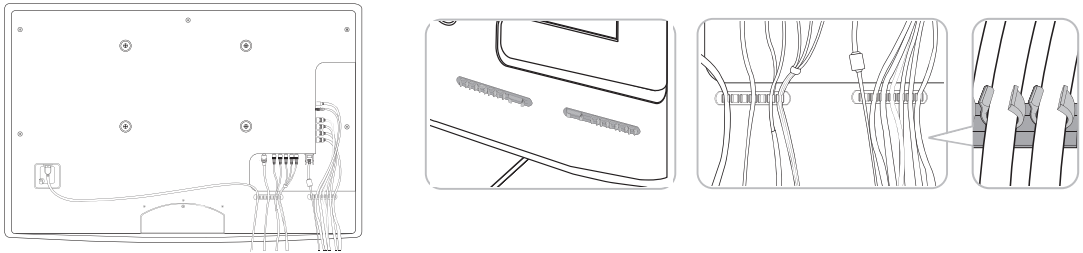

 Do not pull the cables too hard when arranging them. This may cause damage to the product's connection terminals.

Other Information

Installing the Wall Mount

Assembling the Blanking Bracket

When installing the TV onto a wall, attach the Blanking Bracket as shown.

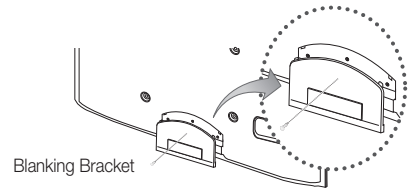

Assembling Power-Cord

When installing the TV onto a wall, attach the Power-Cord as shown.

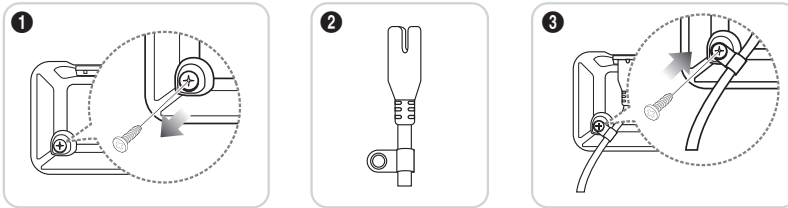

1. Remove the screw shown in the first picture above.
2. Attach the power cord clamp to the power cord.
3. Mount the power cord clamp to the TV, using the removed screw, as shown.

Preparing before installing Wall-Mount

Case A. Installing the SAMSUNG Wall-Mount

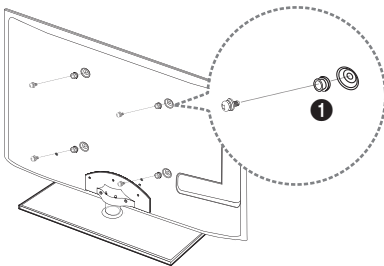

Case B. Installing another company's Wall-Mount

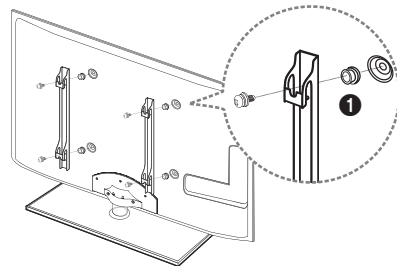

To install a wall-mount, use the Holder-Ring ①.

Installing the Wall Mount Kit

The wall mount kit (sold separately) allows you to mount the TV on the wall.

For detailed information on installing the wall mount, see the instructions provided with the wall mount. Contact a technician for assistance when installing the wall mount bracket.

Samsung Electronics is not responsible for any damage to the product or injury to yourself or others if you elect to install the TV on your own.

Wall Mount Kit Specifications (VESA)

 The wall mount kit is not supplied, but sold separately.

Install your wall mount on a solid wall perpendicular to the floor. When attaching to other building materials, please contact your nearest dealer. If installed on a ceiling or slanted wall, it may fall and result in severe personal injury.

NOTE

- Standard dimensions for wall mount kits are shown in the table below.
- When purchasing our wall mount kit, a detailed installation manual and all parts necessary for assembly are provided.
- Do not use screws that do not comply with the VESA standard screw specifications.
- Do not use screws that are longer than the standard dimension or do not comply with the VESA standard screw specifications. Screws that are too long may cause damage to the inside of the TV set.
- For wall mounts that do not comply with the VESA standard screw specifications, the length of the screws may differ depending on the wall mount specifications.
- Do not fasten the screws that are too strongly; this may damage the product or cause the product to fall, leading to personal injury. Samsung is not liable for these kinds of accidents.
- Samsung is not liable for product damage or personal injury when a non-VESA or non-specified wall mount is used or the consumer fails to follow the product installation instructions.
- Do not mount the TV at more than a 15 degree tilt.

Product Family	inches	VESA Spec. (A * B)	Standard Screw	Quantity
LED-TV [Ultra-Slim]	19~22	75 X 75	M4	4
	23~29	200 X 100	M8	
	32~37	200 X 200		
	40~55	400 X 400		
	56~65	600 X 400		

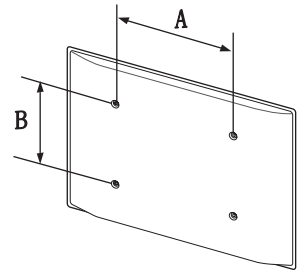

Do not install your Wall Mount Kit while your TV is turned on. It may result in personal injury due to electric shock.

Other Information

Anti-theft Kensington Lock

The Kensington Lock is not supplied by Samsung. It is a device used to physically fix the system when using it in a public place. The appearance and locking method may differ from the illustration depending on the manufacturer. Refer to the manual provided with the Kensington Lock for additional information on proper use.

 Please find a “K” icon on the rear of the TV. A Kensington slot is beside the “K” icon.

To lock the product, follow these steps:

1. Wrap the Kensington lock cable around a large, stationary object such as desk or chair.
2. Slide the end of the cable with the lock attached through the looped end of the Kensington lock cable.
3. Insert the locking device into the Kensington slot on the product (❶).
4. Lock the lock.

 These are general instructions. For exact instructions, see the User manual supplied with the locking device.

 The locking device has to be purchased separately.

 The location of the Kensington slot may be different depending on the TV model.

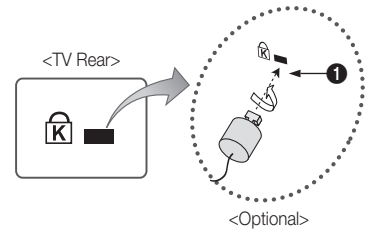

Securing the TV to the wall



Caution: Pulling, pushing, or climbing onto the TV may cause the TV to fall. In particular, ensure that your children do not hang over or destabilize the TV; doing so may cause the TV to tip over, resulting in serious injuries or death. Follow all safety precautions provided in the included Safety Flyer. For added stability and safety, install the anti-fall device as follows.

To Avoid the TV from Falling

1. Put the screws into the clamps and firmly fasten them onto the wall. Confirm that the screws have been firmly installed onto the wall.

 You may need additional material such as an anchor depending on the type of wall.

 Since the necessary clamps, screws, and string are not supplied, please purchase these additionally.

2. Remove the screws from the back centre of the TV, put the screws into the clamps, and then fasten the screws onto the TV again.

 Screws may not be supplied with the product. In this case, please purchase the screws of the following specifications.

 Screw Specifications

- For a 19 ~ 22 inches: M4
- For a 23 ~ 65 inches: M8

3. Connect the clamps fixed onto the TV and the clamps fixed onto the wall with a strong cable and then tie the string tightly.

 **NOTE**

- Install the TV near to the wall so that it does not fall backwards.
- It is safe to connect the string so that the clamps fixed on the wall are equal to or lower than the clamps fixed on the TV.
- Untie the cable before moving the TV.

4. Verify all connections are properly secured. Periodically check connections for any sign of fatigue for failure. If you have any doubt about the security of your connections, contact a professional installer.

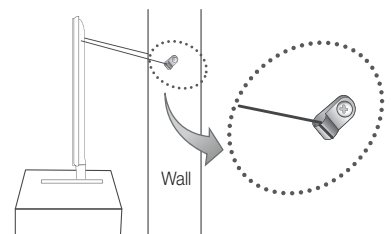
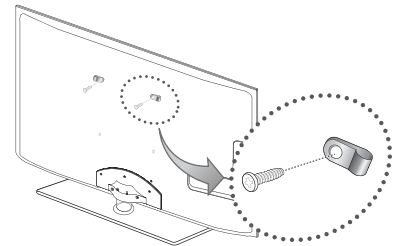

Troubleshooting

If you have any questions about the TV, first refer to this list. If none of these troubleshooting tips apply, please visit “www.samsung.com,” then click on Support, or contact the call centre listed on the back-cover of this manual.

Issues	Solutions and Explanations
Picture Quality	First of all, please perform the Picture Test and confirm that your TV is properly displaying test image. (go to MENU - Support - Self Diagnosis - Picture Test) (p. 22) If the test image is properly displayed, the poor picture may be caused by the source or signal.
The TV image does not look as good as it did in the store.	<ul style="list-style-type: none"> • If you have an analogue cable/set top box, upgrade to a digital set top box. Use HDMI or Component cables to deliver HD (high definition) picture quality. • Cable/Satellite subscribers: Try HD stations from the channel line up. • Antenna connection: Try HD stations after performing Auto programme.  Many HD channels are up scaled from SD(Standard Definition) contents. • Adjust the Cable/Set top box video output resolution to 1080i or 720p. • Make sure you are watching the TV at the minimum recommended distance based on the size and definition of the signal.
The picture is distorted: macro block error, small block, dots, pixelization	<ul style="list-style-type: none"> • Compression of video contents may cause picture distortion especially in fast moving pictures such as sports and action movies. • Low signal level or bad quality can cause picture distortion. This is not a TV issue. • Mobile phones used close to the TV (cca up to 1m) may cause noise in picture on analog and digital TV.
Colour is wrong or missing.	<ul style="list-style-type: none"> • If you're using a component connection, make sure the component cables are connected to the correct jacks. Incorrect or loose connections may cause colour problems or a blank screen.
There is poor colour or brightness.	<ul style="list-style-type: none"> • Adjust the Picture options in the TV menu. (go to Picture mode / Colour / Brightness / Sharpness) (p. 15) • Adjust Energy Saving option in the TV menu. (go to MENU - Picture - Eco Solution - Energy Saving) (p. 15) • Try resetting the picture to view the default picture settings. (go to MENU - Picture - Picture Reset) (p.17)
There is a dotted line on the edge of the screen.	<ul style="list-style-type: none"> • If the picture size is set to Screen Fit, change it to 16:9 (p. 16). • Change cable/set top box resolution.
The picture is black and white.	<ul style="list-style-type: none"> • If you are using an AV composite input, connect the video cable (yellow) to the Green jack of component input 1 on the TV.
When changing channels, the picture freezes or is distorted or delayed.	<ul style="list-style-type: none"> • If connected with a cable box, please try to reset the cable box. Reconnect the AC cord and wait until the cable box reboots. It may take up to 20 minutes. • Set the output resolution of the cable box to 1080i or 720p.
Sound Quality	First of all, please perform the Sound Test to confirm that your TV audio is properly operating. (go to MENU - Support - Self Diagnosis - Sound Test) (p. 22) If the audio is OK, the sound problem may be caused by the source or signal.
There is no sound or the sound is too low at maximum volume.	<ul style="list-style-type: none"> • Please check the volume of the external device connected to your TV.
The picture is good but there is no sound.	<ul style="list-style-type: none"> • Set the Speaker Select option to TV Speaker in the sound menu (p. 18). • If you are using an external device, make sure the audio cables are connected to the correct audio input jacks on the TV. • If you are using an external device, check the device's audio output option (ex. you may need to change your cable box's audio option to HDMI when you have a HDMI connected to your TV). • If you are using a DVI to HDMI cable, a separate audio cable is required. • If your TV has a headphone jack, make sure there is nothing plugged into it.
The speakers are making an inappropriate noise.	<ul style="list-style-type: none"> • Check the cable connections. Make sure a video cable is not connected to an audio input. • For antenna or cable connections, check the signal strength. Low signal level may cause sound distortion.
No Picture, No Video	
The TV won't turn on.	<ul style="list-style-type: none"> • Make sure the AC power cord is securely plugged in to the wall outlet and the TV. • Make sure the wall outlet is working. • Try pressing the POWER button on the TV to make sure the problem is not the remote. If the TV turns on, refer to “The remote control does not work” below.
The TV turns off automatically.	<ul style="list-style-type: none"> • Ensure the Sleep Timer is set to Off in the Setup menu (p. 19). • If your PC is connected to the TV, check your PC power settings. • Make sure the AC power cord is plugged in securely to the wall outlet and the TV. • When watching TV from an antenna or cable connection, the TV will turn off after 10 - 15 minutes if there is no signal.

Other Information

Issues	Solutions and Explanations
There is no picture/Video.	<ul style="list-style-type: none"> • Check cable connections (remove and reconnect all cables connected to the TV and external devices). • Set your external devices' (Cable/Set top Box, DVD, Blu-ray etc) video outputs to match the connections to the TV input. For example, if an external device's output is HDMI, it should be connect to an HDMI input on the TV. • Make sure your connected devices are powered on. • Be sure to select the TV's correct source by pressing the SOURCE button on the TV remote.
RF(Cable/Antenna) Connection	
The TV is not receiving all channels.	<ul style="list-style-type: none"> • Make sure the Antenna cable is connected securely. • Please try Plug & Play (Initial setup) to add available channels to the channel list. Go to MENU - Setup - Plug & Play (Initial setup) and wait for all available channels to be stored (p. 7). • Verify the Antenna is positioned correctly.
The picture is distorted: macro block error small block, dots, pixelization	<ul style="list-style-type: none"> • Compression of video contents may cause picture distortion, especially with fast moving pictures such as sports and action movies. • A low signal can cause picture distortion. This is not a TV issue.
PC Connection	
A "Mode Not Supported" message appears.	<ul style="list-style-type: none"> • Set your PC's output resolution and frequency so they match the resolutions supported by the TV (p. 23).
"PC" is always shown on the source list, even if a PC is not connected.	<ul style="list-style-type: none"> • This is normal; "PC" is always shown on the source list, regardless of whether a PC is connected.
The video is OK but there is no audio.	<ul style="list-style-type: none"> • If you are using a HDMI connection, check the audio output setting on your PC.
Network Connection (Depending on Models)	
Wireless network connection failed.	<ul style="list-style-type: none"> • Samsung Wireless USB dongle is required to use a wireless network. • Make sure the Network Connection is set to Wireless (p. 26). • Make sure the TV is be connected to a wireless IP sharer (router).
Others	
The picture won't display in full screen.	<ul style="list-style-type: none"> • HD channels will have black bars on either side of the screen when displaying up scaled SD (4:3) contents. • Black bars on the top and bottom will appear during movies that have aspect ratios different from your TV. • Adjust the picture size options on your external device or TV to full screen.
The remote control does not work.	<ul style="list-style-type: none"> • Replace the remote control batteries with the poles (+/-) in the right direction. • Clean the sensor's transmission window on the remote. • Try pointing the remote directly at the TV from 5-6 feet away.
The cable/set top box remote control doesn't turn the TV on or off, or adjust the volume.	<ul style="list-style-type: none"> • Programme the Cable/Set top box remote control to operate the TV. Refer to the Cable/Set user manual for the SAMSUNG TV code.
A "Mode Not Supported" message appears.	<ul style="list-style-type: none"> • Check the supported resolution of the TV, and adjust the external device's output resolution accordingly. Refer to the resolution settings on page 23 of this manual.
There is a plastic smell from the TV.	<ul style="list-style-type: none"> • This smell is normal and will dissipate over time.
The TV Signal Information is unavailable in the Self Diagnostic Test menu.	<ul style="list-style-type: none"> • This function is only available with digital channels from an Antenna / RF / Coax connection (p. 22).
The TV is tilted to the side.	<ul style="list-style-type: none"> • Remove the base stand from the TV and reassemble it.
There are difficulties assembling the stand base.	<ul style="list-style-type: none"> • Make sure the TV is placed on a flat surface. If you can not remove the screws from the TV, use a magnetized screw driver.
The channel menu is greyed out. (unavailable)	<ul style="list-style-type: none"> • The Channel menu is only available when the TV source is selected.
Your settings are lost after 30 minutes or every time the TV is turned off.	<ul style="list-style-type: none"> • If the TV is in the Store Demo mode, it will reset audio and picture settings every 30 minutes. Change the settings from Store Demo mode to Home Use mode in the Plug & Play (Initial setup) procedure. Press the SOURCE button to select TV mode, and go to MENU → Setup → Plug & Play (Initial setup) → ENTER  (p. 7).
You have intermittent loss of audio or video.	<ul style="list-style-type: none"> • Check the cable connections and reconnect them. • Loss of audio or video can be caused by using overly rigid or thick cables. Make sure the cables are flexible enough for long term use. If mounting the TV to the wall, we recommend using cables with 90 degree connectors.

Issues	Solutions and Explanations
You see small particles when you look closely at the edge of the frame of the TV.	<ul style="list-style-type: none"> This is part of the product's design and is not a defect.
The PIP menu is not available.	<ul style="list-style-type: none"> PIP functionality is only available when you are using a HDMI, PC or components source (p. 21).
The message "Scramble signal" or "Weak Signal/No Signal" appears.	<ul style="list-style-type: none"> If you are using a CAM CARD (CI/CI+), check that it is installed into the common interface slot. If there is still a problem, pull the CAM CARD out of the TV and insert it into the slot again.
You turned the TV off 45 minutes ago, and it turned on again.	<ul style="list-style-type: none"> It is normal. The TV operates the OTA (Over The Aerial) function itself to upgrade firmware downloaded whilst your watching TV.
There are recurrent picture/sound issues.	<ul style="list-style-type: none"> Check and change the signal/source.
A reaction may occur between the rubber cushion pads on the base stand and the top finish of some furniture.	<ul style="list-style-type: none"> To prevent this, use felt pads on any surface of the TV that comes in direct contact with furniture.

 This TFT LED panel uses a panel consisting of sub pixels which require sophisticated technology to produce. However, there may be a few bright or dark pixels on the screen. These pixels will have no impact on the performance of the product.

Licence



Manufactured under licence from Dolby Laboratories. Dolby and the double-D symbol are trademarks of Dolby Laboratories.



Manufactured under licence under U.S. Patent #'s: 5,451,942; 5,956,674; 5,974,380; 5,978,762; 6,487,535 & other U.S. and worldwide patents issued & pending. DTS and the Symbol are registered trademarks. & DTS 2.0+ Digital Out and the DTS logos are trademarks of DTS, Inc. Product Includes software. © DTS, Inc. All Rights Reserved.



DivX Certified to play DivX video up to HD 1080p, including premium content.

ABOUT DIVX VIDEO: DivX® is a digital video format created by DivX, Inc. This is an official DivX Certified device that plays DivX video. Visit www.divx.com for more information and software tools to convert your files into DivX video.

ABOUT DIVX VIDEO-ON-DEMAND: This DivX Certified® device must be registered in order to play DivX Video-on-Demand (VOD) content.

To generate the registration code, locate the DivX VOD section in the device setup menu.

Go to vod.divx.com with this code to complete the registration process and learn more about DivX VOD. Pat. 7,295,673; 7,460,688; 7,519,274

Open Source Licence Notice

In the case of using open source software, Open Source Licences are available on the product menu.

Open Source Licence Notice is written only English.

Other Information

Specifications

Panel native	1920 x 1080	
Environmental Considerations		
Operating Temperature	10°C to 40°C (50°F to 104°F)	
Operating Humidity	10% to 80%, non-condensing	
Storage Temperature	-20°C to 45°C (-4°F to 113°F)	
Storage Humidity	5% to 95%, non-condensing	
TV System	Analogue: B/G, D/K, L, I (Depending on your country selection) Digital: DVB-T/DVB-C/DVB-T2(UK Only)	
Colour/Video System	Analogue: PAL, SECAM, NTSC-4.43, NTSC-3.58, PAL60 Digital: MPEG-2 MP@ML, MPEG-4, H.264/AVC MP@L3, MP@L4.0, HP@L4.0	
Sound System	BG, OK NICAM, MPEGI	
HDMI IN 1 ~ 4	Video: 1080 24p, 1080p, 1080i, 720p, 576p, 576i, 480p, 480i Audio: 2Ch Linear PCM 32/44.1/48kHz, 16/20/24bits. Analogue audio input (HDMI IN1 only) PC input (HDMI IN1 only)	
Stand Swivel (Left / Right)	-20° ~ 20°	
Model Name	UE32C5800	UE37C5800
Screen Size (Diagonal)	32 inches	37 inches
Sound (Output)	10W X 2	
Dimensions (WxDxH) Body	785.0 X 29.9 X 491.0 mm	908.0 X 29.9 X 561.0 mm
With stand	785.0 X 240.0 X 550.0 mm	908.0 X 255.0 X 621.0 mm
Weight Without Stand	8.2 kg	10.6 kg
With Stand	11.0 kg	14.2 kg
Model Name	UE40C5800	UE46C5800
Screen Size (Diagonal)	40 inches	46 inches
Sound (Output)	10W X 2	
Dimensions (WxDxH) Body	972.0 X 29.9 X 596.0 mm	1107.0 X 29.9 X 671.0 mm
With stand	972.0 X 255.0 X 621.0 mm	1107.0 X 275.0 X 731.0 mm
Weight Without Stand	12.1 kg	15.7 kg
With Stand	15.7 kg	19.7 kg

 Design and specifications are subject to change without prior notice.

 For information about power supply, and more about power consumption, refer to the label attached to the product.

Correct Disposal of This Product (Waste Electrical & Electronic Equipment)

(Applicable in the European Union and other European countries with separate collection systems)

This marking on the product, accessories or literature indicates that the product and its electronic accessories (e.g. charger, headset, USB cable) should not be disposed of with other household waste at the end of their working life. To prevent possible harm to the environment or human health from uncontrolled waste disposal, please separate these items from other types of waste and recycle them responsibly to promote the sustainable reuse of material resources. Household users should contact either the retailer where they purchased this product, or their local government office, for details of where and how they can take these items for environmentally safe recycling. Business users should contact their supplier and check the terms and conditions of the purchase contract. This product and its electronic accessories should not be mixed with other commercial wastes for disposal.



Correct disposal of batteries in this product

(Applicable in the European Union and other European countries with separate battery return systems)

This marking on the battery, manual or packaging indicates that the batteries in this product should not be disposed of with other household waste at the end of their working life. Where marked, the chemical symbols Hg, Cd or Pb indicate that the battery contains mercury, cadmium or lead above the reference levels in EC Directive 2006/66. If batteries are not properly disposed of, these substances can cause harm to human health or the environment. To protect natural resources and to promote material reuse, please separate batteries from other types of waste and recycle them through your local, free battery return system.



Index

A

AllShare	40
Amplify	17
Antenna	13
Anynet+	37
Auto Adjustment	17
Auto Volume	18

B

Background Music	36
Balance L/R	18
Basic View	35
Batteries	6
Black Tone	15
Blanking Bracket	44
Brightness	15

C

Component	8
Cable Tie	4, 43
Change PIN	20
Channel Manager	12
Channel Menu	13
Clock	19
Colour Tone	16
Connecting to an Audio Device	9
Connecting to a PC	23

D

DIGITAL AUDIO OUT	9, 37
DivX® VOD	36
D-sub	23
Dynamic	15
Dynamic Contrast	15

E

Edit Name	10
EPG (Electronic Programme Guide)	11
Editing Channels	14
Energy Saving	15
Eco Sensor	15
Equalizer	18
External Speaker	18

F

Film Mode	17
Fine Tune	14
Flesh Tone	16
Frequency	13

H

HDMI	8, 37
Headphones	9
Home Theatre	9, 37

I

Installation Space	2
--------------------	---

L

Language	20
Licence	49
Lock	14

M

Media Play	30
Melody	21
Menu Transparency	21
Music	34
My Channels	13

N

Navigate	11
Network Connection	24
Network Setup	25
Now & Next guide	11

O

ON/OFF button	6
Optimal resolution	23

P

Photos	34
Picture Size	16, 36
PIP (Picture in Picture)	21
Plug & Play	7
Power Indicator	5

R

Receiver	39
Recording	38
Remote Control	6
Repeat Mode	36
RGB Only Mode	15
Rotate	36

S

Select All	14
Self Diagnosis	22
Sharpness	15
Signal Information	22
Sleep Timer	19
Slide Show	34
Software Upgrade	22
Source List	10
Speaker Select	18
Specifications	50
Standby mode	5
Subtitle	20
Symbol	3

T

Timer	19
Title	35
Tools	3
Troubleshooting	47
TV Speaker	18

U

USB Drive	22, 30
Using Channel View	11
Using Scheduled View	12
Using the Favourite Channels	13

V



Video Formats	33
Videos	32
Volume	5

W

Wall Mount	44
Warm	16
White Balance	16

Warning! Important Safety Instructions

Please read the appropriate section that corresponds to the marking on your Samsung product before attempting to install the product.

CAUTION	 This symbol indicates that high voltage is present inside. It is dangerous to make any kind of contact with any internal part of this product.
RISK OF ELECTRIC SHOCK DO NOT OPEN	
CAUTION: TO REDUCE THE RISK OF ELECTRIC SHOCK, DO NOT REMOVE COVER (OR BACK). THERE ARE NO USER SERVICEABLE PARTS INSIDE. REFER ALL SERVICING TO QUALIFIED PERSONNEL.	 This symbol alerts you that important literature concerning operation and maintenance has been included with this product.

- The slots and openings in the cabinet and in the back or bottom are provided for necessary ventilation. To ensure reliable operation of this apparatus, and to protect it from overheating, these slots and openings must never be blocked or covered.
 - Do not cover the slots and openings with a cloth or other materials.
 - Do not block the slots and openings by placing this apparatus on a bed, sofa, rug or other similar surface.
 - Do not place this apparatus in a confined space, such as a bookcase, or built-in cabinet, unless proper ventilation is provided.
 - Give your product 10 cm (4 inch) clearance from the wall.
- Do not place this apparatus near or over a radiator or heat resistor, or where it is exposed to direct sunlight.
- Do not place heat generating items such as candles, ashtrays, incense, flammable gas or explosive materials near the product.
- Do not place a water containing vessel on this apparatus, as this can result in a risk of fire or electric shock.
- Do not expose this apparatus to rain or place it near water (near a bathtub, washbowl, kitchen sink, or laundry tub, in a wet basement, or near a swimming pool etc.). If this apparatus accidentally gets wet, unplug it and contact an authorized dealer immediately. Make sure to pull out the power cord from the outlet before cleaning.
- This apparatus uses batteries. In your community there might be regulations that require you to dispose of these batteries properly under environmental considerations. Please contact your local authorities for disposal or recycling information.
- Do not overload wall outlets, extension cords or adaptors beyond their capacity, since this can result in fire or electric shock.
- Power-supply cords should be routed so that they are not likely to be walked on or pinched by items placed upon or against them, paying particular attention to cords at plug end, adaptors and the point where they exit from the appliance.
- To protect this apparatus from a lightning storm, or when it is left unattended and unused for long periods of time, unplug it from the wall outlet and disconnect the antenna or cable system.
This will prevent damage to the set due to lightning and power line surges.
- Before connecting the AC power cord to the DC adaptor outlet, make sure the voltage designation of the DC adaptor corresponds to the local electrical supply.
- Never insert anything metallic into the open parts of this apparatus. Doing so may create a danger of electric shock.
- To avoid electric shock, never touch the inside of this apparatus. Only a qualified technician should open this apparatus.
- Make sure to plug the power cord in until it is firmly inserted. When removing the power cord, make sure to hold the power plug when pulling the plug from the outlet. Do not touch the power cord with wet hands.
- If this apparatus does not operate normally - in particular, if there are any unusual sounds or smells coming from it - unplug it immediately and contact an authorized dealer or service centre.
- Be sure to pull the power plug out of the outlet if the TV is to remain unused or if you are to leave the house for an extended period of time (especially when children, elderly or disabled people will be left alone in the house).
 - Accumulated dust can cause an electric shock, an electric leakage or a fire by causing the power cord to generate sparks and heat or the insulation to deteriorate.
- Be sure to contact an authorized service centre, when installing your set in a location with heavy dust, high or low temperatures, high humidity, chemical substances and where it operates for 24 hours such as the airport, the train station etc. Failure to do so may cause serious damage to your set.
- Use only a properly grounded plug and receptacle.
 - An improper ground may cause electric shock or equipment damage. (Class I Equipment only.)
- To disconnect the apparatus from the mains, the plug must be pulled out from the mains socket, therefore the mains plug shall be readily operable.
- Do not allow children to hang onto the product.
- Store the accessories (battery, etc.) in a location safely out of the reach of children.
- Do not install the product in an unstable location such as a shaky shelf, a slanted floor or a location exposed to vibration.
- Do not drop or impart any shock to the product. If the product is damaged, disconnect the power cord and contact a service centre.



**WARNING - TO PREVENT THE SPREAD OF FIRE,
KEEP CANDLES OR OTHER OPEN FLAMES
AWAY FROM THIS PRODUCT AT ALL TIMES.**

Wiring the Mains Power Supply Plug (UK Only)

IMPORTANT NOTICE

The mains lead on this equipment is supplied with a moulded plug incorporating a fuse. The value of the fuse is indicated on the pin face of the plug and, if it requires replacing, a fuse approved to BSI1362 of the same rating must be used.

Never use the plug with the fuse cover omitted if the cover is detachable. If a replacement fuse cover is required, it must be of the same colour as the pin face of the plug. Replacement covers are available from your dealer.

If the fitted plug is not suitable for the power points in your house or the cable is not long enough to reach a power point, you should obtain a suitably approved extension lead or consult your dealer for assistance. However, if there is no alternative but to cut off the plug, remove the fuse and then safely dispose of the plug.

Do NOT connect the plug to a mains socket as there is a risk of shock hazard from the bared flexible cord.

IMPORTANT

The wires in the mains lead are coloured in accordance with the following code:

BLUE - NEUTRAL BROWN - LIVE

As these colours may not correspond to the coloured markings identifying the terminals in your plug, proceed as follows :

The wire coloured BLUE must be connected to the terminal marked with the letter N or coloured BLUE or BLACK. The wire coloured BROWN must be connected to the terminal marked with the letter L or coloured BROWN or RED.

WARNING:

DO NOT CONNECT EITHER WIRE TO THE EARTH TERMINAL, WHICH IS MARKED WITH THE LETTER E OR BY THE EARTH SYMBOL , OR COLOURED GREEN OR GREEN AND YELLOW.

Warranty Card



UNITED KINGDOM

This Samsung product is warranted for a period of twelve (12) months from the original date of purchase, against defective materials and workmanship. In the event that warranty service is required, you should return the product to the retailer from whom it was purchased. However, Samsung Authorised Dealers and Authorised Service Centres in other EC Countries will comply with the warranty on the terms issued to purchasers in the country concerned. In case of difficulty, details of our Authorised Service Centres are available from:

Samsung Electronics U.K. Ltd.
Customer Care Centre
PO Box 17243
Edinburgh, EH11 4YB
United Kingdom
Tel: 0845 SAMSUNG (7267864) (UK & Northern Ireland)
Tel: 0818 717 100 (EIRE Only)
Fax: +44 0845 650 8080
Web : www.samsung.com

WARRANTY CONDITIONS

1. The warranty is only valid if, when warranty service is required, the warranty card is fully and properly completed and is presented with the original invoice or sales slip or confirmation, and the serial number on the product has not been defaced.
2. Samsung's obligations are limited to the repair or, at its discretion, replacement of the product or the defective part.
3. Warranty repairs must be carried out by Authorised Samsung Dealers or Authorised Service Centres. No re-imbursment will be made for repairs carried out by non Samsung Dealers and, any such repair work and damage to the products caused by such repair work will not be covered by this warranty.
4. This product is not considered to be defective in materials nor workmanship by reason that it requires adaptation in order to conform to national or local technical or safety standards in force in any country other than the one for which the product was originally designed and manufactured.